



# Historic Bridge Management Plan for the Bayou Tigre Bridge

Recall Number: 010130

Structure Number: 03573970304251

Parish: Vermilion

Route: LA 330

Crossing Description: Bayou Tigre



Prepared for

**Louisiana Department of  
Transportation and  
Development**

Prepared by

**Mead  
& Hunt**

[www.meadhunt.com](http://www.meadhunt.com)

June 2017

**THIS PAGE INTENTIONALLY LEFT BLANK**

## Table of Contents

|  | Page      |
|--|-----------|
| <b>Executive Summary .....</b>                               | <b>1</b>  |
| <b>1. Introduction .....</b>                                 | <b>3</b>  |
| <b>2. Location Map .....</b>                                 | <b>5</b>  |
| <b>3. Historic Data .....</b>                                | <b>7</b>  |
| A. Identifying information .....                             | 7         |
| B. Description of bridge .....                               | 7         |
| C. History and significance .....                            | 8         |
| D. Character-defining features .....                         | 10        |
| <b>4. Engineering Data.....</b>                              | <b>17</b> |
| A. Existing conditions .....                                 | 17        |
| (1) Structural observations .....                            | 17        |
| (2) Non-structural observations .....                        | 18        |
| (3) Serviceability observations.....                         | 18        |
| B. Sources of information.....                               | 19        |
| <b>5. Recommendations .....</b>                              | <b>33</b> |
| A. Preventative maintenance .....                            | 33        |
| B. Rehabilitation .....                                      | 34        |
| C. Identification of any anticipated design exceptions ..... | 34        |

### Appendices

- A Historic Inventory Form
- B Select Plan Sheets

**THIS PAGE INTENTIONALLY LEFT BLANK**

## Executive Summary

The Bayou Tigre Bridge (Recall No. 010130) is located in Vermilion Parish, Louisiana, and is owned by the State of Louisiana. Constructed in 1960, the bridge was determined eligible for the National Register of Historic Places (National Register) in 2013. It is significant as a distinctive example of a through truss swing bridge featuring a Warren through truss swing span, rim-bearing turning mechanism on a pivot pier, and operator's house centered above the roadway and over the pivot pier.

The bridge carries two lanes of Louisiana Highway (LA) 330 across the Bayou Tigre. The approximately 323-foot-long crossing consists of nine spans, with the main span a steel through truss swing span with a length of 160 feet. The swing span is flanked by five cast-in-place, reinforced-concrete slab spans to the north, and three cast-in-place concrete slab spans to the south. The through truss swing span includes a rim-bearing turning mechanism supported on a pivot pier. This roller-and-track system guides the motion of the bridge when it opens and closes. A pivot bearing also supports the center of the swing span on the pivot pier. The operator's house is supported on a platform at the center of the top of the through truss, with drive machinery for opening and closing the bridge located within. A timber fender system for the waterway navigation extends into the waterway east and west of the truss swing span and provides for a clear horizontal navigation width of 60 feet. The vertical clearance through the bridge is 13 feet, 10 inches. The bridge is classified as a complex structure because it contains one swing span unit. It is also classified as fracture critical because of the two-truss framing system for the main swing span.

The bridge is in fair condition overall and appears to adequately serve its purpose of carrying vehicular traffic, with the ability to open to allow water navigation traffic to pass through the bridge. The major deficiency is the failure of the paint system, including rust, corrosion, and section loss on the structural steel members of the truss swing span. The operation of the bridge is also satisfactory as observed in the opening-closing cycle during the field visit, and the operating machinery is adequately maintained. With proper maintenance and rehabilitation, the Bayou Tigre Bridge can continue to serve in its present capacity for 20 years or longer.

Any work on the bridge should proceed according to recommendations in this Historic Bridge Management Plan (Plan), which adhere to the *Secretary of the Interior's Standards for the Treatment of Historic Properties* (Secretary's Standards), the *Management Plan for Historic Bridges Statewide* (Statewide Historic Bridge Plan), and the *Programmatic Agreement among the Federal Highway Administration, the Louisiana Department of Transportation And Development, the Advisory Council on Historic Preservation, and the Louisiana State Historic Preservation Officer Regarding Management of Historic Bridges in Louisiana* (PA).

**THIS PAGE INTENTIONALLY LEFT BLANK**

## 1. Introduction

This Plan, used in conjunction with the Statewide Historic Bridge Plan, provides guidance on the approach to preservation activities for the Bayou Tigre Bridge (Recall No. 010130), identified as a Preservation Priority Bridge. Completion of individual management plans for Preservation Priority Bridges and the Statewide Historic Bridge Plan fulfills terms of the PA, which was executed on September 21, 2015.

The PA provides the basis and procedures for the management of historic bridges in Louisiana and outlines the procedures for the treatment of historic bridges, including Preservation Priority Bridges. In accordance with the PA, an owner seeking state or federal funding for Preservation Priority Bridges will be required by the Louisiana Department of Transportation and Development (LADOTD), in cooperation with the Louisiana State Historic Preservation Office (LASHPO) and the Federal Highway Administration (FHWA), to follow the procedures outlined in this Plan and the Statewide Historic Bridge Plan.

The Statewide Historic Bridge Plan outlines the overall approach to bridge preservation through a discussion of the collaboration of the historian and engineer, guidance on assessing preservation needs, and resources and technical guidance on maintenance and rehabilitation activities that are broadly applicable to historic bridges. A glossary of common engineering and historical terms is included in the Statewide Historic Bridge Plan.

This Plan for the Bayou Tigre Bridge compiles and summarizes the specific historic and engineering information for this Preservation Priority Bridge. It documents the existing use and condition of the bridge, along with assessments of the preservation needs, including cost estimates. Preservation can be accomplished in two manners: preventative maintenance and rehabilitation. Maintenance includes cyclical or condition-based activities that, along with regular structural inspections, are directed toward continued structure serviceability. Rehabilitation activities are near- or long-term steps that need to be taken to preserve and in some cases restore a bridge's structural condition and serviceability. In assessing preservation activities for each Preservation Priority Bridge, a design life of 20 years was considered, which is consistent with the duration of the PA. This Plan provides the bridge owner, and other interested parties, with detailed information related to the historic nature of the bridge and the necessary background to make an informed planning decision. Recommendations within this Plan should be reviewed in 10 years following completion of the Plan to identify any needed updates or revisions.

Existing bridge data sources typically available for Louisiana bridges were gathered for this Plan, and field investigation confirmed the general structural condition and character-defining features of the subject bridge. These sources include:

- The current LADOTD Bridge Inspection Report, and any other similar inspection reports
- Original bridge construction plans, any rehabilitation plans, and record as-built plans, as available
- Existing historical and documentary material related to the historic bridges

Recommendations within this Plan are consistent with the Secretary's Standards. The Secretary's Standards are basic principles created to help preserve the distinct character of a historic property and its site, while allowing for reasonable change to meet new engineering standards and codes. The Secretary's Standards recommend repairing, rather than replacing, deteriorated features whenever possible. A version of the Secretary's Standards that is specific to historic bridges is included in the Statewide Historic Bridge Plan. Following these standards is a requirement of the PA.

A bridge historian and bridge engineer from Mead & Hunt, Inc. (Mead & Hunt) jointly prepared this Plan under contract to the LADOTD. The LADOTD, FHWA, and LASHPO reviewed and provided input into the final Plan.



## 2. Location Map



0 1,250 2,500 5,000  
Feet

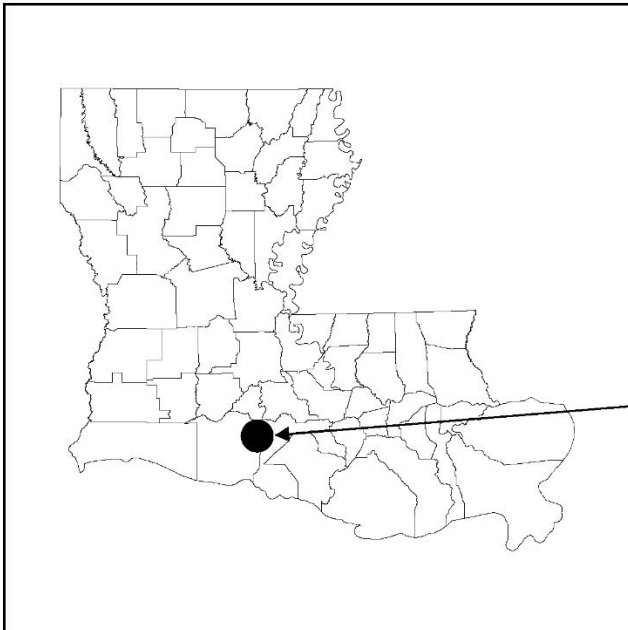

**PROJECT LOCATION**  
Bridge Number: 010130  
Sturcture Number: 03573970304251  
Vermilion Parish  
Route: LA 330  
Crossing Description: Bayou Tigre

**THIS PAGE INTENTIONALLY LEFT BLANK**

### 3. Historic Data

#### A. Identifying information

**Structure Number:** 03573970304251

**Recall Number:** 010130

**LASHPO Number:** 57-00676

**Bridge Name:** Bayou Tigre Bridge

**Date of Construction:** 1960

**Main Span Type:** Movable: Swing – Through truss (Warren truss)

**Contractor:** Unknown

**Designer/Engineer:** Louisiana Department of Highways  
Vincennes Bridge Co., Vincennes, In. (truss)  
Earle Gear & Machine Co., Philadelphia, Pa. (machinery)

#### B. Description of bridge

The Bayou Tigre Bridge carries two lanes of LA 330 across the Bayou Tigre in Vermillion Parish. The average daily traffic (ADT) is approximately 2,200 vehicles. The posted speed limit is an advisory 40 mph, due to a curve in the roadway near the bridge. The approximately 323-foot-long crossing consists of a steel through truss swing span with reinforced-concrete slab approach spans. The bridge is load (weight) posted for 10 to 15 tons (10T-15T). The bridge is classified as a complex structure because it contains one swing span unit. It is also classified as fracture critical because of the two-truss framing system for the main swing span.

The total length of the bridge is approximately 323 feet measured from end bent to end bent. The bridge is described as follows, from north to south.<sup>1</sup> Spans 1 through 5 are cast-in-place, reinforced-concrete slab spans, each 20 feet long for a total length of 100 feet. Spans 6 is the main span—a steel through truss swing span—with a swing span length of 160 feet and a total span length of 162 feet, 10 inches. Spans 7 through 9 are cast-in-place concrete slab spans, each 20 feet long for a total of length of 60 feet. The concrete approach slabs provided at each end of the bridge serve as transitions from the bridge to

---

<sup>1</sup> The original general plan sheet for this bridge numbers the spans from north to south, with the northerly approach span labeled as span 1 and the swing span labeled as span 6. The bridge inspection reports designate 10 spans from south to north, and the swing span is designated as spans 4 and 5.

the roadway pavement. The bridge provides an 18-foot clear roadway width for 2 lanes of traffic, one lane each direction, with a 6-inch curb on each side of the roadway.

The through truss swing span consists of two riveted steel 8-panel Warren trusses, with transverse riveted steel I-beam floorbeams spaced at 20 feet; nine lines of rolled steel I-beam longitudinal stringers; and an open metal grid deck supported by the stringers. The metal grid deck is filled with concrete over the center pivot pier. The main members of the truss span consist of riveted, latticed, rectangular shaped members, with lateral bracing for the top and bottom chords. The through truss swing span includes a rim-bearing turning mechanism supported on a pivot pier. This roller-and-track system guides the motion of the bridge when it opens and closes. A pivot bearing also supports the center of the swing span on the pivot pier. The operator's house is supported on a platform at the center of the top of the through truss, with access provided by a stairway up the house from the roadway level. Drive machinery for opening and closing the bridge is located in the operator's house. Shafts and couplings extend from the operator's house to the turning mechanism.

The truss swing span has an open joint at either end of the span. The railing is steel guardrail bolted to vertical steel I-beams, which are bolted to the outside of the approach spans and through truss span.

The substructure for the approach spans consist of cast-in-place, reinforced-concrete end bents (bents 1 and 8) supported on 14-inch-square precast concrete piles. Bents 2 through 5 and bents 6 and 7 consist of cast-in-place, reinforced-concrete caps supported on 14-inch-square precast concrete piles that form the columns. The substructure for the main span consists of cast-in-place, reinforced-concrete pier caps (piers 1, 2, and 3) supported on 16-inch-square precast concrete piles that form the columns.

The timber fender system for the waterway navigation extends into the waterway east and west of the truss swing span. The timber fender system provides for a clear horizontal navigation width of 60 feet.

The vertical clearance through the bridge is 13 feet, 10 inches. Signs indicating this clearance are located at each end of the swing span.

Traffic warning gates with traffic signals are located along the approach spans at each end of the bridge.

### **C. History and significance**

The Bayou Tigre Bridge is located in eastern Vermilion Parish approximately 1 mile west of the Vermilion/Iberia Parish line and approximately 2.5 miles south of the town of Delcambre. The bridge carries LA 330 over Bayou Tigre. From its eastern terminus in Delcambre, LA 330 runs southwest and then northwest to Abbeville, a total distance of approximately 17 miles. The area surrounding the bridge is rural, with residences scattered on both side of Bayou Tigre. A historic aerial photograph from 1962 shows the area much the same as it is now, with some additional residences.<sup>2</sup> Situated on the

---

<sup>2</sup> 1962 aerial photograph, Delcambre, La., <http://www.historicaerials.com/>.

Delcambre Canal, a tributary ultimately connecting Lake Peigneur with the Gulf of Mexico, Delcambre is a hub for seafood, especially shrimping.<sup>3</sup>

The swing span on the Bayou Tigre Bridge was reused from an older bridge.<sup>4</sup> Built in 1926, that bridge was located on the Houma-Morgan City Highway over the Bayou Boeuf, in St. Mary/Assumption Parishes, between Morgan and Houma. It was comprised of five through truss spans including the one swing span that was later repurposed (with a total length of about 572 feet (including joint spacing between the spans), it included the 160-foot swing span and four 102-foot truss spans). The as-built plan, dated February 1926, indicates that the swing span adhered to standard plan B-2-6 for its 160-foot swing bridge with an 18-foot clear roadway.<sup>5</sup> The Louisiana Department of Highways developed several standard plans for swing-span bridges between 1924 and 1961.<sup>6</sup>

The through truss swing span was built by the Vincennes Bridge Company, which prepared the shop drawings that provided match mark patterns. Founded in southwest Indiana in 1899, the Vincennes Bridge Company was responsible for constructing many truss and movable bridges in southeastern states, including Louisiana. It reincorporated as the Vincennes Steel Corporation in 1932 to reflect the additions of steel manufacturing and contracting to its traditional business of bridge building.<sup>7</sup> The Earle Gear Machine Co. served as the manufacturer of the bridge's mechanical equipment.

Plans for the Bayou Tigre Bridge were prepared by the Louisiana Department of Highways, Bridge Design Section, from 1957 to early 1959, and the plans were approved in May 1959. The plans called for the replacement of a bascule span at the same crossing. Final tracings show the swing truss plan is retraced from construction shop drawings provided from Vincennes Bridge Company in the 1926 as-builts, and one page in the 1959 plan set references the truss as "Contract 2879, 160' Swing Span over Bayou Boeuf, La." Most machinery was reused from the prior site. The operator's house was not retained from the original bridge, although the house is in the same location. The 1959 plan set prepared

---

<sup>3</sup> "Towns: Delcambre," *Vermilion Parish Tourist Commission*, <http://www.vermilion.org/towns/delcambre>.

<sup>4</sup> Retraced construction drawings from Vincennes Bridge Company are included in the as-builts, and one page references the truss as "Contract 2879, 160' Swing Span over Bayou Boeuf, La." State of Louisiana, Department of Highways, as-built plans for the Bayou Tigre Bridge and approaches near Delcambre, Vermilion Parish.

<sup>5</sup> Louisiana Highway Commission, as-built plans for the Bayou Boeuf Bridge on Houma-Morgan City Highway in St. Mary/Assumption Parishes, Federal Aid Project 155B.

<sup>6</sup> Mead & Hunt, "Historic Context for Louisiana Historic Bridge Inventory" (prepared for the Louisiana Department of Transportation and Development, November 2012), 66. The agency was named the Louisiana Highway Commission until 1940, at which time it was changed to the Louisiana Department of Highways.

<sup>7</sup> National Register of Historic Places, Multiple Property Documentation Form, "Historic Bridges of Arkansas," Statewide, Arkansas, E11–E12.

by the Bridge Design Section includes plans and specifications for an operator's house, as well as an equipment list for electrical components.<sup>8</sup>

The total length of the project, covering the bridge and approaches, was 0.3 miles. Construction on the bridge occurred primarily in 1960 at a cost of approximately \$216,000.<sup>9</sup> Although this figure seems low, the reuse of the swing span provided significant cost savings.

Swing bridges were one of the earliest types of movable bridges used in Louisiana, but their popularity began to diminish by the 1930s in favor of bascule and vertical lift bridges, which did not require a pier in the navigation channel.<sup>10</sup> In 2016 the Bayou Tigre Bridge was one of four extant Warren through swing truss on Louisiana's roadways and the only one that is probable to remain in vehicular use. Others include:

- Bayou Teche (1895) on St. John Bridge Road in St. Martin Parish, bypassed by a new bridge in 2002
- Bayou Teche (1938) on Vida Shaw Road in Iberia Parish, which has an uncertain future
- Chef Menteur (1933) carrying U.S. Highway 90 in New Orleans, Orleans Parish, scheduled for replacement

The Bayou Tigre Bridge is eligible for listing in the National Register under *Criterion C: Engineering*. Its significance is demonstrated by the presence of distinctive engineering and design features of a through truss swing bridge. These features include a Warren through truss swing span, rim-bearing turning mechanism with a pivot bearing on a pivot pier, and operator's house centered above the roadway and over the pivot pier. A steel guardrail replaced the original railing on the inside of the truss and extends along the approach spans and roadway. Though the guardrail results in a minor loss of integrity, the bridge continues to convey significant design elements of the through truss swing type.

#### D. Character-defining features

Character-defining features are prominent or distinctive aspects, qualities, or characteristics of a historic property that contribute significantly to its physical character. Features may include materials, engineering design, and structural and decorative details. Elements of the bridge that are not identified as character-defining features may be historic fabric. Historic fabric is material in a bridge that was part of

---

<sup>8</sup> State of Louisiana, Department of Highways, as-built plans for the Bayou Tigre Bridge and approaches near Delcambre, Vermilion Parish.

<sup>9</sup> Louisiana Department of Highways, *Financial and Statistical Report, Fiscal Year Ending June 30, 1961* (Baton Rouge, La.: Louisiana Department of Highways, 1961), 33; State of Louisiana, Department of Highways, *Financial and Statistical Report, Fiscal Year Ended June 30, 1960* (Baton Rouge, La.: Department of Highways, 1960), 34.

<sup>10</sup> Mead & Hunt, Inc., *Crossing the Bayou: Louisiana's Historic Bridges* (prepared for the Louisiana Department of Transportation and Development, 2015), 11.

original construction. It is important to consider both character-defining features and the bridge's historic fabric when planning any work.

The Bayou Tigre Bridge has one character-defining features: its through truss swing span (described below). Other elements that represent historic fabric but are not considered to be character-defining are the truss floor system; concrete substructure elements, including the central pivot pier; approach spans; and operator's house. The steel guardrail was added to the bridge and is not considered historic fabric.

The following item is the character-defining feature of this bridge:

**Feature 1: Design and construction of a through truss swing span**

This feature includes the main through truss swing span, which is in the Warren truss configuration. It also encompasses the bridge's rim-bearing turning mechanism, which consists of a metal roller-and-track system.



*Character-defining Feature Photo 1: Design and construction of a through truss swing span. The main swing span (shown in partially open position) features a Warren through truss.*



*Character-defining Feature Photo 2: Design and construction of a through truss swing span. The main swing span (shown in open position) featuring rim-bearing turning mechanism with a pivot pier. This roller-and-track system guides the motion of the bridge when it opens and closes. Shafts extend from the operator's house to the turning mechanism.*





*Character-defining Feature Photo 3: Design and construction of a through truss swing span. Detail showing the track system and shafts and couplings that connect operating machinery in the operator's house to machinery and gears supported on the pivot pier.*

The following images illustrate other bridge features that are historic fabric, meaning they are part of original construction but are not considered to be character-defining features:



*Historic Fabric Photo 1: Truss floor system.*



*Historic Fabric Photo 2: Operator's house.*



*Historic Fabric Photo 3: Central pivot pier.*



*Historic Fabric Photo 4: Concrete substructure and concrete slab approach spans. This photo also shows the added guardrail, which is not historic fabric.*

**THIS PAGE INTENTIONALLY LEFT BLANK**

## 4. Engineering Data

### A. Existing conditions

#### (1) Structural observations

The Bayou Tigre Bridge is in fair condition overall and appears to adequately serve its purpose of carrying vehicular traffic over the waterway, with the ability to open to allow water navigation traffic to pass by the bridge. The operation of the bridge is also satisfactory as observed in the opening-closing cycle during the field visit, and the operating machinery is adequately maintained. The major deficiency is the failure of the paint system, including rust, corrosion, and section loss on the structural steel members of the truss swing span.

The bridge is load (weight) posted at 10 to 15 tons (10T-15T), with signs indicating this at each end of the bridge.

#### Concrete slab approach spans (spans 1-5 and 7-9)

The cast-in-place, reinforced-concrete deck slabs of the approach spans are in good condition, exhibiting only minor wear. The expansion joints are in satisfactory condition, except that the joint material has failed and vegetation is growing in the joint. The concrete along the joints is cracking and spalling. The open joints are in good condition and free of debris. Additionally, the joint between the approach spans of the bridge and the approach roadway is spalled and cracking. The concrete pile columns for the bents are in good condition, exhibiting wear at the waterline. The bent caps are in good condition, exhibiting water staining from the runoff from the deck drains and minor vegetation growth. Bent caps 6 and 7 have minor spalling at the key. End bents 1 and 8 have heavy vegetation growth; therefore, end bent 8 could not be observed. The steel guardrail along either side of the bridge approach spans is in satisfactory condition, with timber spacers rotated and paint system failure of the vertical steel posts. The concrete curbs are in satisfactory condition with heavy water staining and minor spalling and cracking.

#### Swing steel truss span 6

The open metal grid deck of the truss swing spans is in good condition with small spot repairs and minor corrosion on the top of the deck. The grid deck over the pivot pier is concrete filled and is in good condition, with minor concrete pop-outs. The open joints are in good condition with minor debris. The truss span superstructure steel is in poor condition with paint system failure and corrosion throughout. The stringers and floorbeams have paint system failure and heavy corrosion throughout. The truss steel has areas of heavy to light pack rust. The gusset plate at the lower chord, second connection (L2) has sections of 100 percent section loss. The concrete pile columns for the bents exhibit wear at the waterline and the bent caps exhibit water staining from the runoff from the deck drains. The guardrail along either side of the bridge is in satisfactory condition. The guardrail has rust staining from the truss superstructure and the steel toe bumper below the guardrail is heavily corroded. The operating machinery is functional and generally in satisfactory condition. The exposed machinery is rusting, but functioning properly.

The gears have been replaced, although one gear under the operator's house is still missing teeth. The operating electrical system is functional and in satisfactory condition. The opening/closing cycle of the truss span was loud, slow and bounced a minimal amount, although rotated well. The locks are in good condition, and function properly with no deficiencies.

**(2) Non-structural observations**

The traffic gates at each end of the bridge are lowered when the bridge is opened, and are in satisfactory functional and structural condition, although the timber is beginning to deteriorate. The lights on the gates are working and in good condition.

The navigation lights are in good condition and are working properly, although one of the navigation lights on the timber fender system is broken.

The operator's house is in fair condition and fully functional. The operator's house is located at the top, center of the truss span, and is supported on a structural steel platform. The building is showing much wear due to age. The ladder access for the house is narrow and exhibits areas of section loss and is damaged. The railings around the platform are rusted and corroded. The original windows are in fair condition, with the timber casing paint system failing and the metal casing rusting. The control panel is in satisfactory condition and fully functional.

The original timber fender system is in good condition with a few missing timber members and heavy vegetation growth.

The deck striping on both the open and filled metal grid deck on the truss swing span is faded.

The condition of the concrete approach slabs at each end of the bridge is good with no deficiencies.

**(3) Serviceability observations**

The ADT across the bridge is approximately 2,200 vehicles. The posted advisory speed limit across the bridge is 40 mph. The bridge clear roadway width of 18 feet provides for two lanes of traffic, one in each direction, with narrow curbs on each side of the roadway. The bridge adequately handles this traffic volume. The horizontal and vertical geometry of the bridge is good. The railing on the bridge is guardrail supported by steel I-beams bolted to the steel structure.

The bridge is not manned, and four hours advance notification is required for bridge openings. The bridge is opened on average one time per month.

**B. Sources of information**

**Plans available:** Yes, available at the LADOTD Bridge Section office  
**Inspection report date:** March 2, 2016  
**Fracture critical report date:** (included as part of routine inspection report)  
**Underwater inspection report:** March 26, 2014  
**Date of site visit:** February 4, 2016



*Condition Photo 1: North approach span looking north. Note metal guardrail, approach slab, and traffic gates.*



*Condition Photo 2: South approach roadway looking south; note guardrail and traffic gates.*



*.Condition Photo 3: North roadway approach looking south toward the bridge. Note warning features and general view approaching the swing span.*





*Condition Photo 4: Main span truss paint failure.*



*Condition Photo 5: Elevation view of the north concrete approach spans and main span truss, exhibiting concrete staining and paint failure.*



*Condition Photo 6: Close-up of the rollers and steel ring track at the center pivot pier (Pier 2) under the truss span.*



*Condition Photo 7: Opening of the swing truss span.*



*Condition Photo 8: Diagonal member of the main span truss paint failure.*



*Condition Photo 9: Lower chord paint failure of the main truss span.*



*Condition Photo 10: End of the main truss span showing paint failure as well as the condition of the live load bearings and locks.*



*Condition Photo 11: Steel live load bearing for the main truss span.*



*Condition Photo 12: Signage attached to a vertical member of the truss.*



*Condition Photo 13: Damaged guardrail on the main span.*



*Condition Photo 14: Concrete filled metal grid deck wear and spalling on truss span.*



*Condition Photo 15: Condition of metal grid deck on the swing span.*



*Condition Photo 16: Spalled concrete curb and debris north approach at the joint for the approach slab and bridge approach spans.*



*Condition Photo 17: Vegetation growth at the north approach bents; similar condition at south approach bents.*



*Condition Photo 18: Water staining and vegetation growth on approach Bents 3-5 and Pier 1*



*Condition Photo 19: Operator's house centered on top of the main truss span.*





*Condition Photo 20: Gears and shafts for the swing span under the operator house at the center on top of the truss; note the newer steel beam and column which replaced in-kind deteriorated original steel members.*



*Condition Photo 21: Control console in the operator's house.*



*Condition Photo 22: Motor and machinery in the operator's house.*



*Condition Photo 23: Timber fender system vegetation growth.*



*Condition Photo 24: Broken navigation light on the timber fender system.*



*Condition Photo 25: Swing and approach span piers and condition of the swing span.*

**THIS PAGE INTENTIONALLY LEFT BLANK**

## 5. Recommendations

This Preservation Priority Bridge should be rehabilitated so it can remain in use and meet projected transportation needs for the next 20 years or more. Rehabilitation work should have a goal to remove any load posting on the bridge or, as a minimum, improve the load posting. Maintenance and rehabilitation activities should be completed in a manner consistent with the long-term preservation of this historic bridge. The Statewide Historic Bridge Plan provides additional guidance and approaches to completing maintenance and rehabilitation activities that adhere to the Secretary's Standards. Work should be conducted under the supervision of a qualified professional historian, as defined in the PA. The bridge engineer, or the bridge engineer's supervising engineer, should have demonstrated expertise in historic bridge projects and must have completed the LADOTD's historic bridge training. When developing plans and specifications for a project, the bridge engineer should follow the recommendations below.

Under the terms agreed upon in the PA, the bridge owner may undertake certain activities that are considered to be best practices without additional consultation or public notification. These activities are documented in Attachment 5 of the PA and are limited to the activities specifically noted. All recommended preventative maintenance and rehabilitation activities for this bridge are included in Attachment 5 and are not expected to alter character-defining features or historic fabric of the bridge. Some cyclical or condition-based maintenance items are noted below under Rehabilitation because they are expected to be completed as part of an overall rehabilitation project for this bridge. These activities may need to be completed as conditions dictate to promote long-term preservation of this historic bridge. Recommendations within this Plan should be reviewed in 10 years following completion of the Plan to identify any needed updates or revisions.

The opinions of probable costs provided below are in 2016 dollars. The costs were developed without benefit of preliminary rehabilitation plans and are based on the above identified tasks using engineering judgment and/or gross estimates of quantities and historic unit prices and are intended to provide a programming level of estimated costs. Refinement of the probable costs is recommended once preliminary plans have been developed. The estimated preservation costs include a 10% contingency and 7% mobilization allowance of the preservation activities, excluding soft costs. Actual costs may vary significantly from those opinions of cost provided herein. Engineering design, historical consultation, and construction administration costs are not included as these may be provided by the owner or consultants.

### A. Preventative maintenance

The following recommendations are for cyclical maintenance. Because these activities are routinely done, costs are not included in the cost estimate. There are no condition-based maintenance recommendations at this time, based on the bridge condition as observed during the site visit and as documented in available information.

1. Lubricate operating machinery for the bridge regularly to maintain good condition.
2. Remove vegetation overgrowth from substructure units regularly.
3. Replace timber members missing from the fender protection system and remove vegetation growth regularly to maintain good condition.

4. Repair and realign the blocking for the steel guardrail system on the approach spans.
5. Replace the broken navigation light on the timber fender system.

**B. Rehabilitation**

The following are recommendations for rehabilitation. These activities should be performed when necessary (estimated to be within the next five years):

1. Clean and paint the entire swing truss span structural steel framing system, including the structural steel framing system for the operator’s house, in accordance with the current standard cleaning and painting specification.
2. Repair or replace deteriorated structural steel on the truss swing span, including the stairway for access to the operator’s house.
3. Clean and paint the exterior of the operator’s house.
4. Replace the gear with the missing teeth under the operator’s house.

| Bridge Recall No. 010130   |          |      | Date:       | 4/28/2017          |  |
|--|----------|------|-------------|--------------------|--|
| Bayou Tigre Bridge   |          |      |             |                    |  |
| Opinion of Probable Costs  |          |      |             |                    |  |
| Rehabilitation   |          |      |             |                    |  |
| Item   | Quantity | Unit | Unit Cost   | Total              |  |
| Clean and paint the entire swing truss span structural steel framing system, including the structural steel framing system for the operator’s house, in accordance with the current standard cleaning and painting specification | 1        | LS   | \$500,000   | \$500,000          |  |
| Repair or replace deteriorated structural steel on the truss swing span, including the stairway to the operator’s house  | 1        | LS   | \$1,000,000 | \$1,000,000        |  |
| Clean and paint the exterior of the operator’s house   | 1        | LS   | \$5,000     | \$5,000            |  |
| Replace gear with missing teeth under the operator’s house   | 1        | LS   | \$5,000     | \$5,000            |  |
| Traffic control signage, drums and temporary pavement marking for staged construction of items listed above  | 1        | LS   | \$25,000    | \$25,000           |  |
|  |          |      |             |                    |  |
| Item Subtotal  |          |      |             | \$1,535,000        |  |
| Contingency  |          |      | 10.00%      | \$153,500          |  |
| Mobilization   |          |      | 7.00%       | \$118,195          |  |
|  |          |      |             |                    |  |
| <b>TOTAL ESTIMATED CONSTRUCTION COST</b>   |          |      |             | <b>\$1,806,695</b> |  |
|  |          |      | Round to:   | <b>\$1,807,000</b> |  |

**C. Identification of any anticipated design exceptions**

No design exceptions were noted, nor are any design exceptions recommended.

**Appendix A. Historic Inventory Form**

**THIS PAGE INTENTIONALLY LEFT BLANK**



# Louisiana Historic Bridge Inventory

Recall Number: 010130

Structure Number: 03573970304251

SHPO Number: 57-00676

Bridge Name: TIGRE BAYOU

## Location Data:

District: 03

Parish: Vermilion

Feature Crossed: BAYOU TIGRE

Facility Carried: LA0330

Location: 4.25 MI WEST OF LA 685

City, Village or Town (if applicable):

Status: Open

Bridge Owner: State of Louisiana

Latitude: 29.916472

Longitude: -91.998917

---

## Structural Data:

Bridge Type: Steel High Truss Swing Span

Year Built: 1960

Main Span Configuration (if applicable): Through truss swing span (Warren)

Maximum Span Length (feet): 163

Number of Spans: 1

Overall Structure Length (feet): 323

Approach Span Type (if applicable): Concrete slab

Posted Load: 10-15

Current ADT: 001440

---

## Design and Construction Data:

Engineer or Builder:

Unknown

Bridge Plaque:

None

---

## National Register of Historic Places Evaluation:

This Warren through truss swing bridge has significance as an important example of a movable bridge and as a subtype. Its significance is demonstrated by the presence of distinctive engineering and design features of a through truss swing bridge, which is characterized by the Warren truss configuration, center-bearing turning mechanism, pivot pier, and operator's house centered above the roadway, over the pivot pier. The bridge exhibits alterations to the original railing that result in a minor loss of integrity, but continues to convey significant design features within the swing bridge type. This bridge is eligible for listing in the National Register under Criterion C: Design/Engineering.

No evidence was found during research or data collection activities to indicate that this bridge possesses a direct and important association with historical events or trends. This bridge does not possess significance under Criterion A.

---

Within/Adjacent to Known Historic District: N/A

National Register Historic District Name: N/A

National Register Determination: Eligible

National Register Determination Date: 2013

Surveyor: Mead & Hunt, Inc.

Date Surveyed: 2013



# Louisiana Historic Bridge Inventory

Recall Number: 010130

Structure Number: 03573970304251

Bridge Name: TIGRE BAYOU

Parish: Vermilion

Bridge Owner: State of Louisiana

Feature Crossed: BAYOU TIGRE

Facility Carried: LA0330

## Photographs:



**Appendix B. Select Plan Sheets**

**THIS PAGE INTENTIONALLY LEFT BLANK**

65

|               |           |           |
|---------------|-----------|-----------|
| STATE PROJECT | PARISH    | SHEET NO. |
| 397-03-07     | VERMILION | 4         |

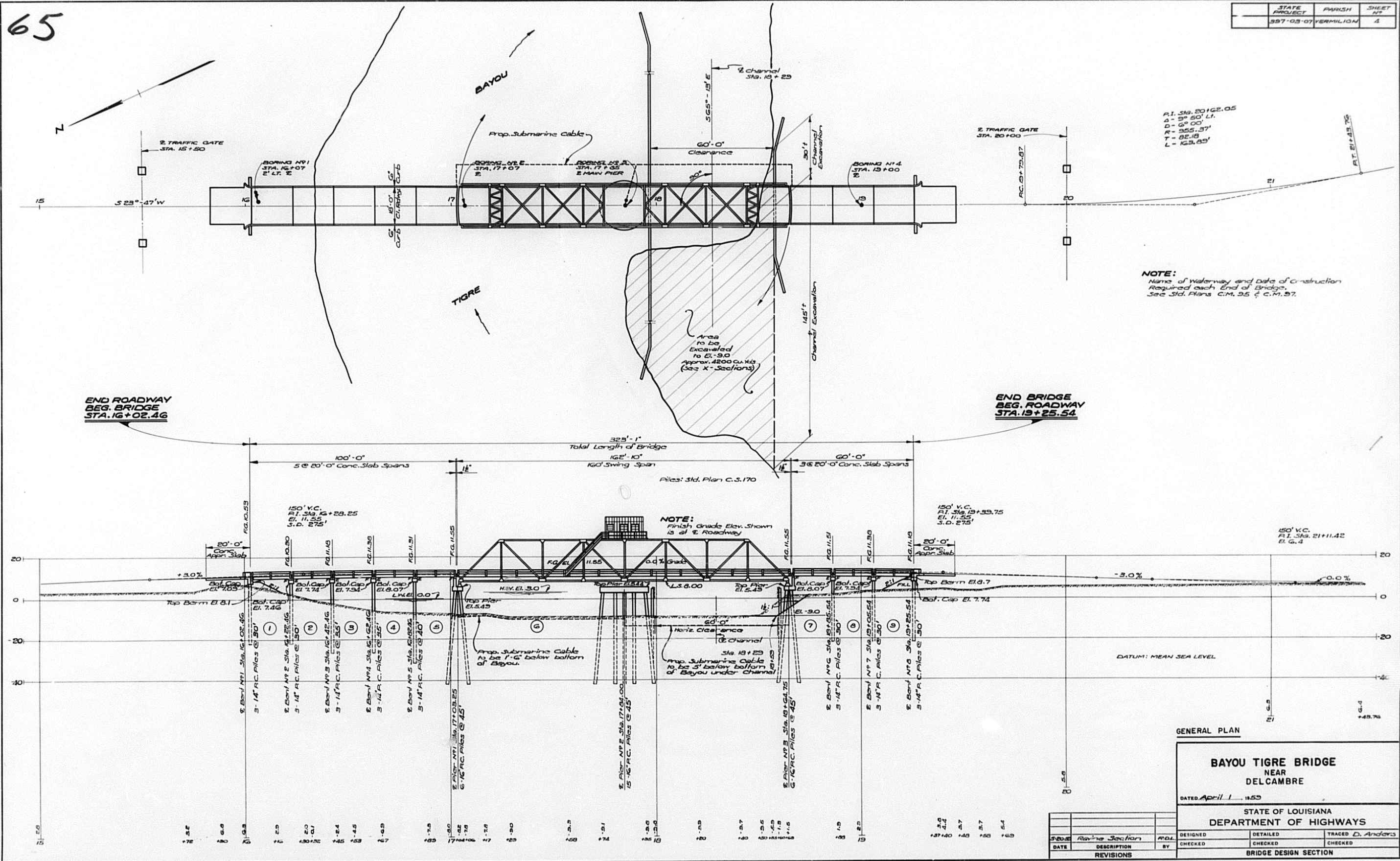

R.I. 58.20+22.05  
 A = 5° 50' Lt.  
 D = 6° 00'  
 R = 255.37'  
 T = 82.18'  
 L = 163.85'

**NOTE:**  
 Name of Waterway and Date of Construction  
 Required each End of Bridge.  
 See Std. Plans C.M. 35 & C.M. 37.

**NOTE:**  
 Finish Grade Elev. Shown  
 is at E. Roadway

**GENERAL PLAN**

**BAYOU TIGRE BRIDGE**  
 NEAR  
 DELCambre

DATED April 1, 1955

STATE OF LOUISIANA  
 DEPARTMENT OF HIGHWAYS

|          |          |         |
|----------|----------|---------|
| DESIGNED | DETAILED | TRACED  |
| CHECKED  | CHECKED  | CHECKED |

BRIDGE DESIGN SECTION

| NO. | DATE | DESCRIPTION     | BY |
|-----|------|-----------------|----|
| 1   |      | Revised Section |    |

FINAL TRACINGS

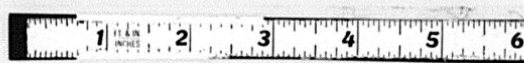



69

|               |            |           |
|---------------|------------|-----------|
| STATE PROJECT | PARISH     | SHEET NO. |
| 557-09-07     | Vermillion | 4         |

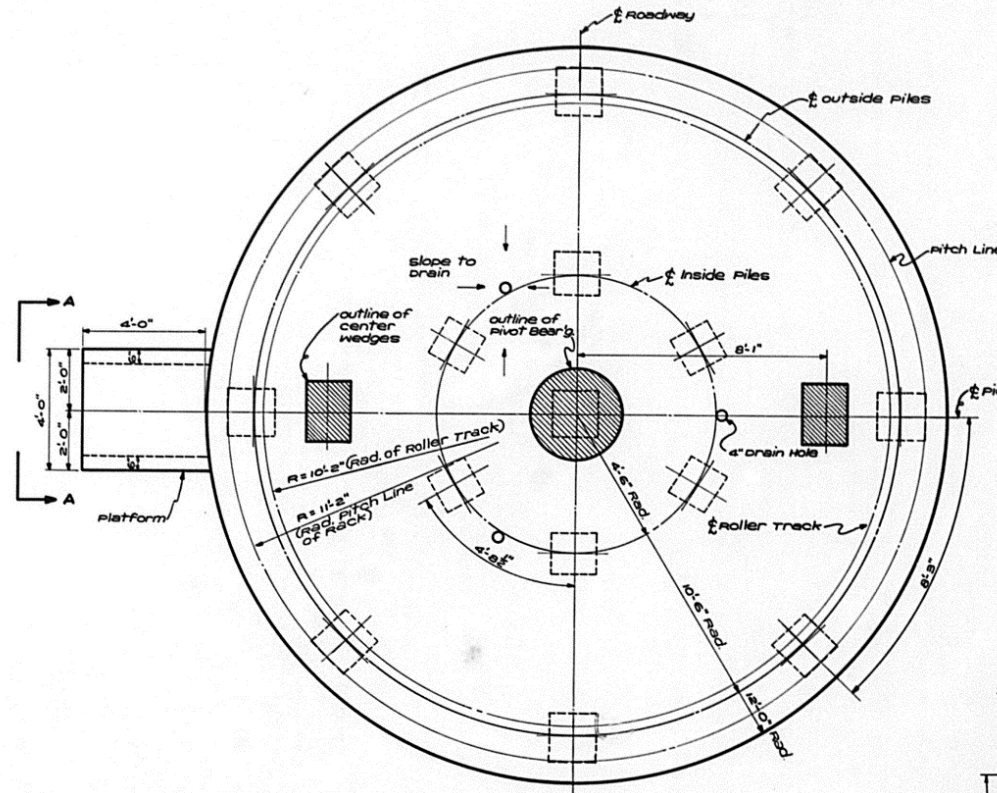

NOTE:  
2-4" holes  
reg'd in Pier  
cap for Submarine  
Cable. Locate  
same in Field.

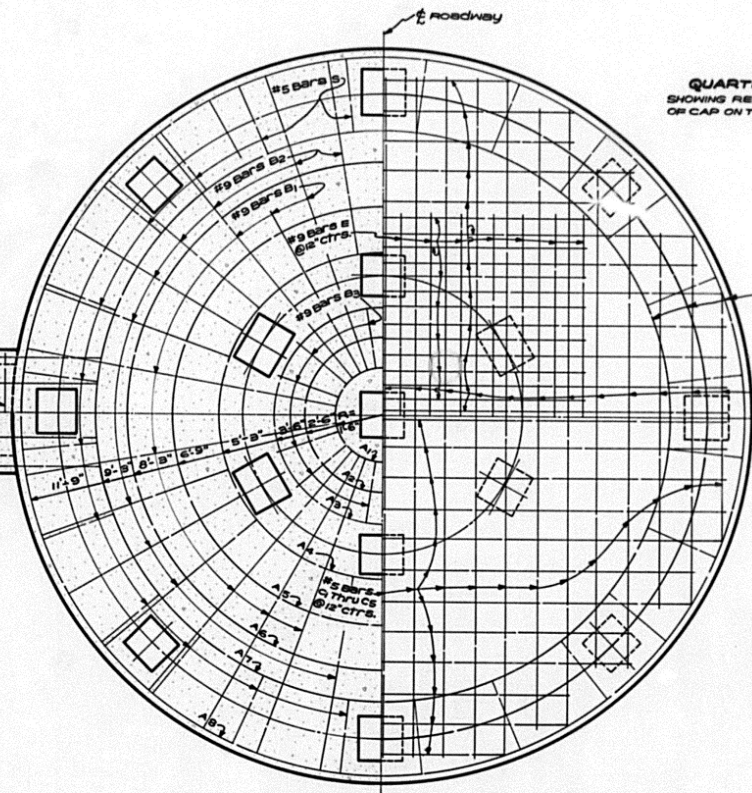
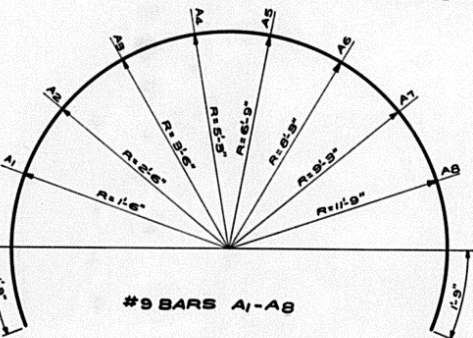

QUARTER PLAN  
SHOWING REINFORCING IN BOTTOM  
OF CAP ON TOP OF PILES

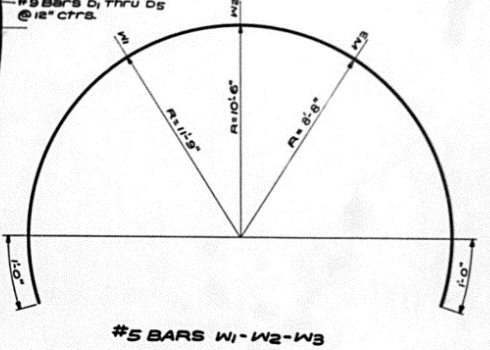

| QUANTITIES                            |      |             |              |                         |
|---------------------------------------|------|-------------|--------------|-------------------------|
| BAR NO.                               | SIZE | UNIT LENGTH | TOTAL LENGTH | LOCATION                |
| C1                                    | #5   | 22'-2"      | 399'-0"      | Top of Cap              |
| C2                                    | #5   | 20'-2"      | 161'-4"      | Top of Cap              |
| C3                                    | #5   | 16'-2"      | 129'-4"      | Top of Cap              |
| C4                                    | #5   | 12'-2"      | 97'-4"       | Top of Cap              |
| C5                                    | #5   | 8'-2"       | 32'-8"       | Top of Cap              |
| S                                     | #5   | 12'-9"      | 306'-0"      | Shirrup                 |
| W1                                    | #5   | 28'-11"     | 77'-10"      | Top of Cap              |
| W2                                    | #5   | 25'-0"      | 70'-0"       | Top of Cap              |
| W3                                    | #5   | 23'-3"      | 56'-6"       | Top of Cap              |
| P1                                    | #5   | 6'-7"       | 26'-4"       | Platform                |
| P2                                    | #5   | 15'-6"      | 27'-0"       | Platform                |
| P3                                    | #5   | 3'-8"       | 23'-4"       | Platform                |
| TOTAL #5 BARS = 1414'-8" = 1476 LBS.  |      |             |              |                         |
| A1                                    | #9   | 15'-2"      | 366'-8"      | Bot of Cap - Over Piles |
| A2                                    | #9   | 11'-4"      | 26'-8"       | Bot of Cap              |
| A3                                    | #9   | 14'-6"      | 28'-0"       | Bot of Cap              |
| A4                                    | #9   | 20'-0"      | 40'-0"       | Bot of Cap              |
| A5                                    | #9   | 24'-8"      | 49'-4"       | Bot of Cap              |
| A6                                    | #9   | 29'-5"      | 58'-10"      | Bot of Cap              |
| A7                                    | #9   | 32'-7"      | 65'-2"       | Bot of Cap              |
| A8                                    | #9   | 40'-5"      | 80'-10"      | Bot of Cap              |
| B1                                    | #9   | 10'-4"      | 165'-4"      | Bot of Cap              |
| B2                                    | #9   | 6'-8"       | 106'-8"      | Bot of Cap              |
| B3                                    | #9   | 2'-2"       | 26'-0"       | Bot of Cap              |
| D1                                    | #9   | 22'-2"      | 599'-0"      | Bot of Cap - Over Piles |
| D2                                    | #9   | 20'-2"      | 161'-4"      | Bot of Cap - Over Piles |
| D3                                    | #9   | 16'-2"      | 129'-4"      | Bot of Cap - Over Piles |
| D4                                    | #9   | 12'-2"      | 97'-4"       | Bot of Cap - Over Piles |
| D5                                    | #9   | 8'-2"       | 32'-8"       | Bot of Cap - Over Piles |
| TOTAL #9 BARS = 1040'-8" = 6286 LBS.  |      |             |              |                         |
| TOTAL DER REINF. STEEL = 7546 LBS.    |      |             |              |                         |
| TOTAL CLASS "A" CONC. = 50.12 CU YDS. |      |             |              |                         |
| MAX. PILE LOAD = 21.2 TONS/PILE       |      |             |              |                         |

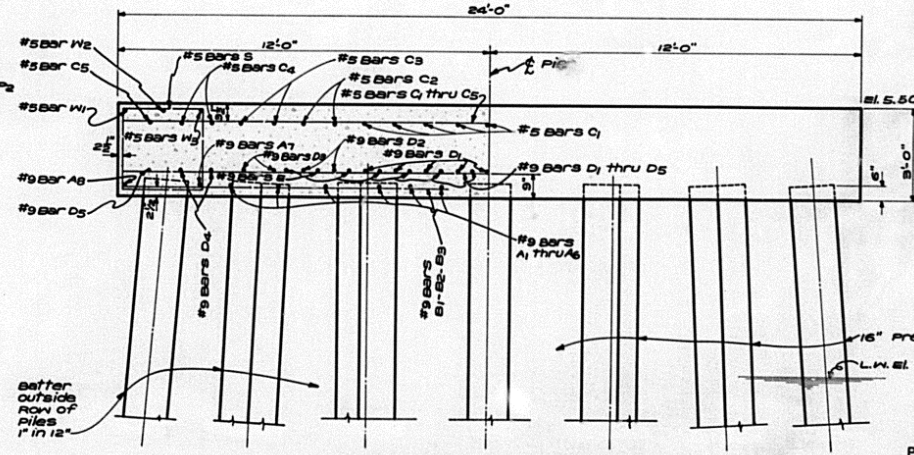
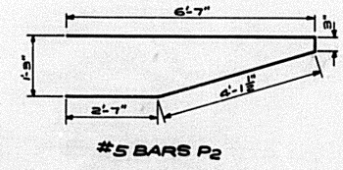
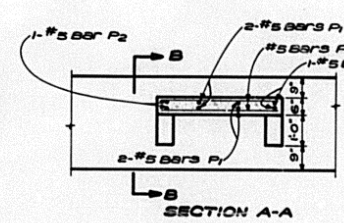
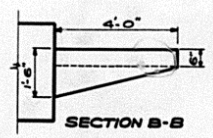
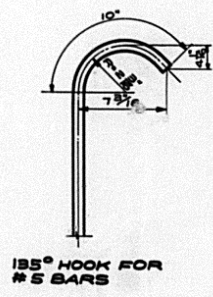

GENERAL NOTES:  
Construction Specs: Latest Approved La. Dept. of Hwys. Std. Specs.  
Reinforcing Bars shall be Intermediate or Hard Grade A.S.T.M. A15 or Rail Steel A.S.T.M. A16. Amended to Dec. 31, 1955.  
Live Load: HS-44.  
All dimensions to Reinforcing Steel are to bar centers.  
Chamfer Exposed Corners 1/4\"/>

NOTE:  
1. Raise pivot pier 3/4\"/>

PIER NO. 2

**BAYOU TIGRE BRIDGE**  
NEAR  
DELCAMBRE

DATED FEB. 11 1959

STATE OF LOUISIANA  
DEPARTMENT OF HIGHWAYS

|                       |                       |                          |
|-----------------------|-----------------------|--------------------------|
| DESIGNED <i>Cully</i> | DETAILED <i>Cully</i> | TRACED <i>A. Chapman</i> |
| CHECKED <i>Nease</i>  | CHECKED <i>P. Lee</i> | CHECKED <i>Nease</i>     |

BRIDGE DESIGN SECTION

| NO. | DATE | DESCRIPTION | BY |
|-----|------|-------------|----|
|     |      |             |    |

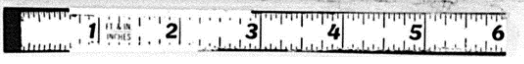

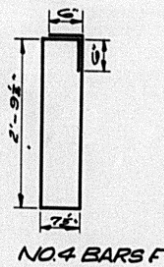
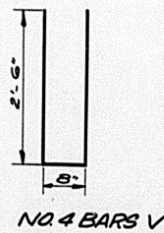
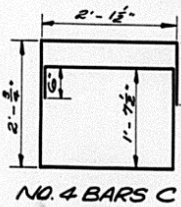
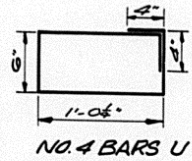
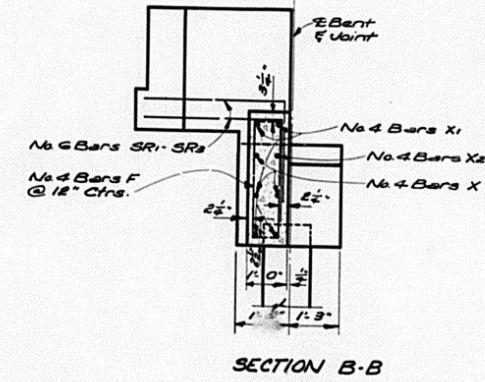
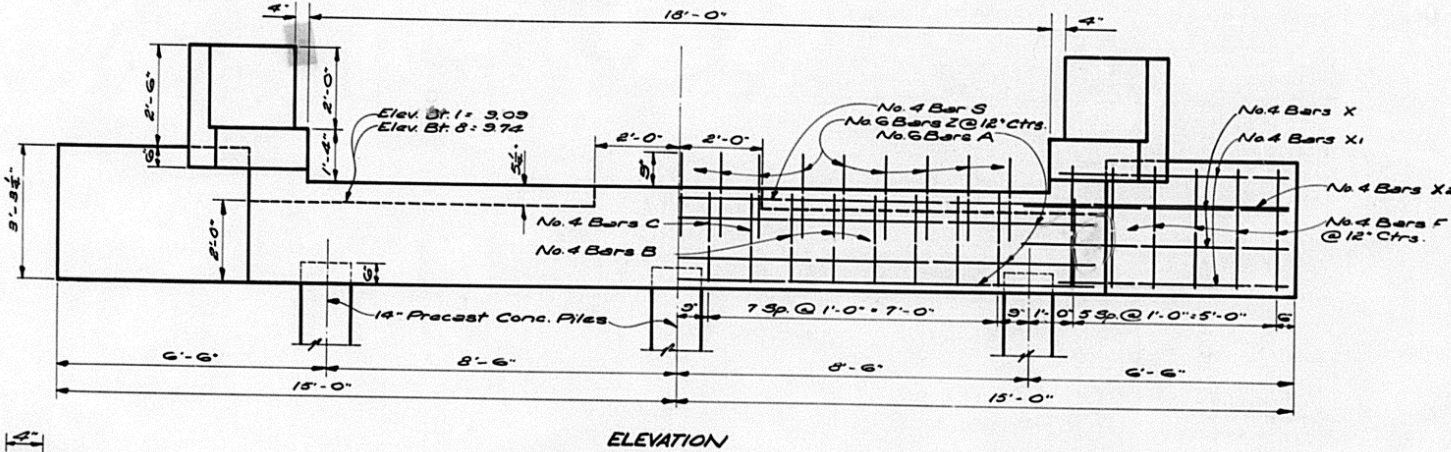
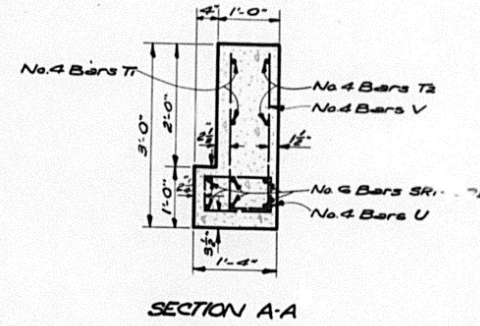
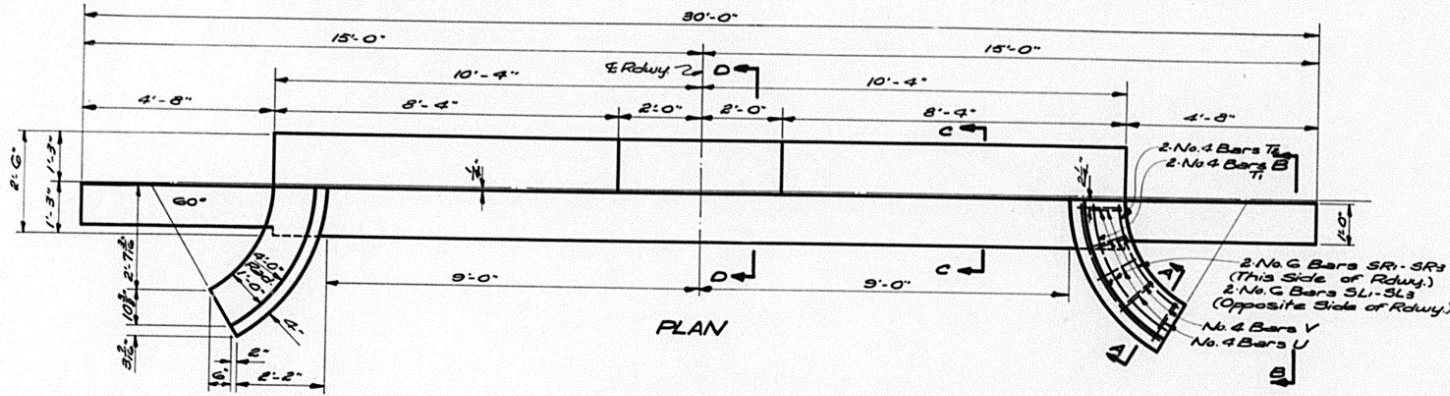

ELEVATION OF BARS SL & SR  
 SL1-SL3 ONLY  
 SR1-SR2 ONLY

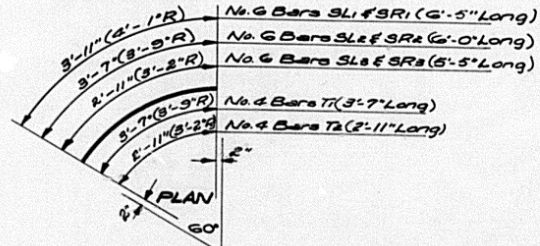

NO. 6 BARS SL1-SL3, NO. 6 BARS SR1-SR2  
 & NO. 4 BARS T1-T2

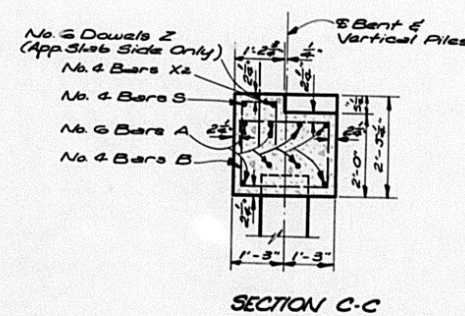
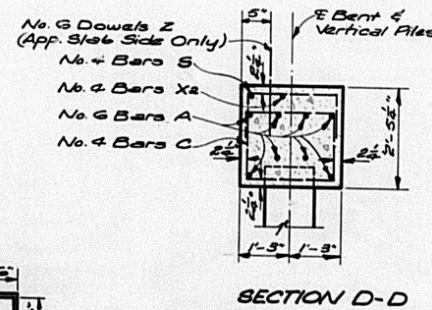

| BILL OF REINFORCING STEEL       |       |               |                        |               |                        |
|---------------------------------|-------|---------------|------------------------|---------------|------------------------|
| BENTS NO. 1 OR NO. 8 (ONE BENT) |       |               |                        |               |                        |
| MARK                            | SIZE  | NO.           | UNIT LENGTH            | TOTAL LENGTH  | LOCATION               |
| A                               | No. 8 | 20            | 4'                     | 162'-8"       | Longit. in Cap         |
| SL1                             | No. 6 | 2             | 6'-5"                  | 12'-10"       | Curved Bars in Flare   |
| SL2                             | No. 6 | 2             | 6'-0"                  | 12'-0"        | Curved Bars in Flare   |
| SL3                             | No. 6 | 2             | 5'-5"                  | 10'-10"       | Curved Bars in Flare   |
| SR1                             | No. 6 | 2             | 6'-5"                  | 12'-10"       | Curved Bars in Flare   |
| SR2                             | No. 6 | 2             | 6'-0"                  | 12'-0"        | Curved Bars in Flare   |
| SR3                             | No. 6 | 2             | 5'-5"                  | 10'-10"       | Curved Bars in Flare   |
| Z                               | No. 6 | 17            | 2'-0"                  | 34'-0"        | Dowels in Cap          |
|                                 |       |               | TOTAL NO. 6 BARS = 266 | 0' = 403 LBS. |                        |
| B                               | No. 4 | 14            | 10'-4"                 | 144'-8"       | Hoops in Cap           |
| C                               | No. 4 | 4             | 11'-7"                 | 46'-4"        | Hoops in Cap           |
| F                               | No. 4 | 12            | 7'-10"                 | 94'-0"        | Hoops in End Walls     |
| T1                              | No. 4 | 4             | 3'-7"                  | 14'-4"        | Curved Bars in Flares  |
| T2                              | No. 4 | 4             | 2'-11"                 | 11'-8"        | Curved Bars in Flares  |
| U                               | No. 4 | 10            | 3'-8"                  | 36'-8"        | Hoops in Flares        |
| V                               | No. 4 | 8             | 5'-8"                  | 45'-4"        | Bent in Flares         |
| X                               | No. 4 | 6             | 6'-8"                  | 40'-0"        | Longit. in Walls       |
| X1                              | No. 4 | 8             | 5'-8"                  | 45'-4"        | Longit. in Walls       |
| X2                              | No. 4 | 7             | 29'-8"                 | 209'-8"       | Longit. in Wall of Cap |
| Y                               | No. 4 | 1             | 20'-4"                 | 20'-4"        | Longit. in Cap         |
|                                 |       |               | TOTAL NO. 4 BARS = 528 | 0' = 553 LBS. |                        |
| QUANTITIES (ONE BENT)           |       |               |                        |               |                        |
| CLASS "A" CONCRETE              |       | 626 CU. YDS.  |                        |               |                        |
| DEFORMED REINF. STEEL           |       | 756 LBS.      |                        |               |                        |
| AVERAGE PILE LOAD               |       | 21.6 TON/PILE |                        |               |                        |

|  |         |         |
|--|---------|---------|
| BENTS NO. 1 & NO. 8                          |         |         |
| BAYOU TIGRE BRIDGE<br>NEAR<br>DELCAMBRE      |         |         |
| DATED March 26 1959                          |         |         |
| STATE OF LOUISIANA<br>DEPARTMENT OF HIGHWAYS |         |         |
| DESIGNED                                     | TRACED  |         |
| CHECKED                                      | CHECKED | CHECKED |
| BRIDGE DESIGN SECTION                        |         |         |

| DATE | DESCRIPTION | BY |
|------|-------------|----|
|      |             |    |

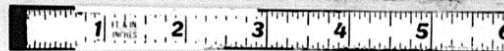



71

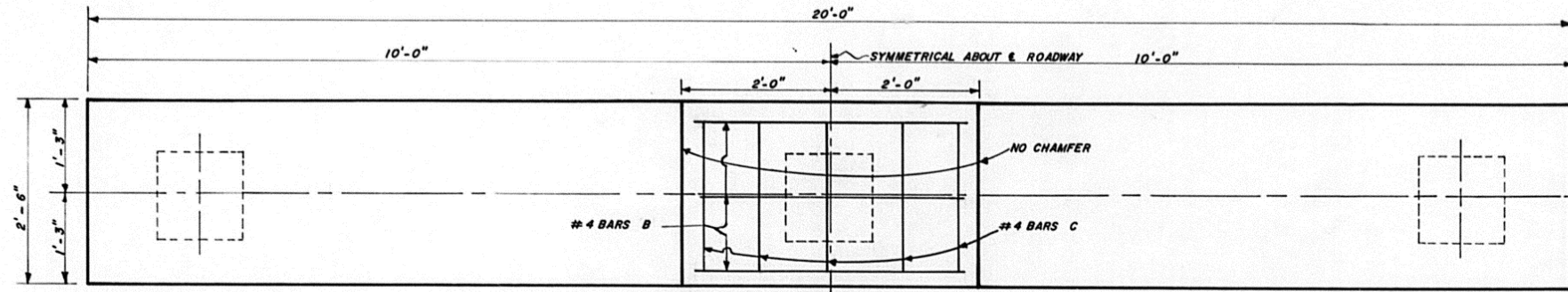

**PLAN**  
SHOWING DIMENSIONS AND RISER REINFORCING

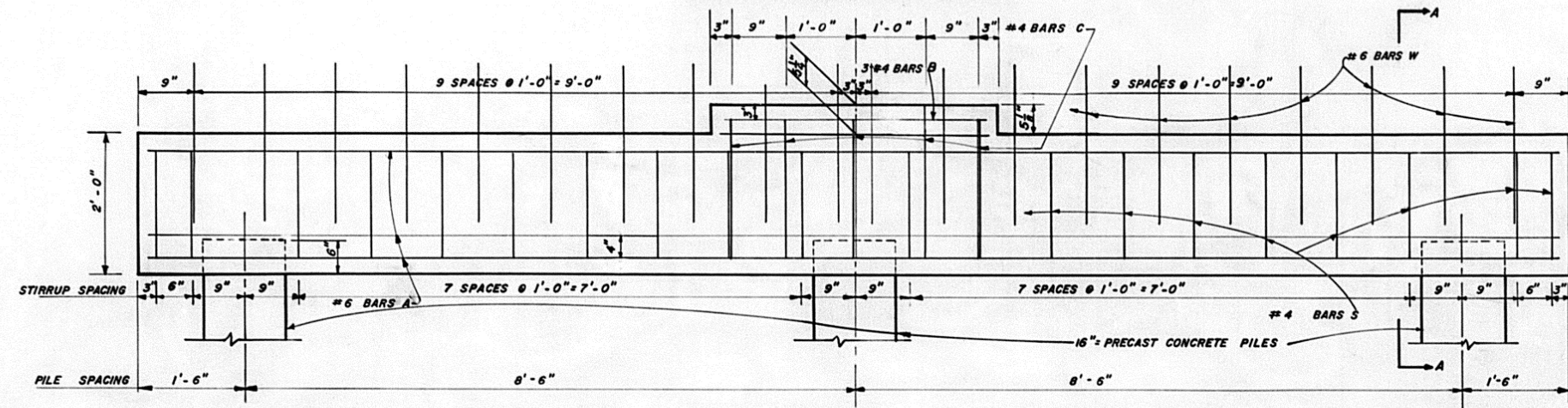

| BILL OF MATERIAL FOR ONE BENT |      |    |        |              |                 |
|-------------------------------|------|----|--------|--------------|-----------------|
| BAR                           | SIZE | NO | LENGTH | TOTAL LENGTH | LOCATION        |
| A                             | #6   | 8  | 19'-8" | 157'-4"      | CAP             |
| W                             | #6   | 20 | 2'-3"  | 45'-0"       | DOWELS          |
| TOTAL #6 BARS @ 2'-4 1/2"     |      |    |        |              | 304 LBS.        |
| B                             | #4   | 3  | 3'-8"  | 11'-0"       | RISER           |
| C                             | #4   | 5  | 6'-0"  | 30'-0"       | RISER           |
| S                             | #4   | 20 | 8'-6"  | 170'-0"      | STIRRUPS IN CAP |
| TOTAL #4 BARS @ 211'-0"       |      |    |        |              | 141 LBS.        |
| TOTAL DEF. REINF. STEEL =     |      |    |        |              | 445 LBS.        |
| CLASS "A" CONCRETE =          |      |    |        |              | 3.79 CU YD.     |
| PILE LOAD =                   |      |    |        |              | 21.6 TONS/PILE  |

\*MAX ALLOWABLE PILE LOAD = 28 TONS / PILE

**GENERAL NOTES:**  
 CONSTRUCTION SPECS: LATEST APPROVED LA. DEPT. OF HWYS STANDARD SPECS.  
 DESIGN SPECS: A.A. S.H.O. STANDARD SPECS. FOR HIGHWAY BRIDGES, AS AMENDED TO DEC. 31, 1955.  
 LIVE LOAD: H 15-44.  
 DIMENSIONS RELATING TO REINFORCING STEEL ARE TO BAR CENTERS.  
 REINFORCEMENT BARS SHALL BE INTERMEDIATE OR HARD GRADE A.S.T.M. A15, OR RAIL STEEL, A.S.T.M. A16.  
 ALL CONCRETE TO BE CLASS "A".  
 ALL EXPOSED ENDS OF #6 DOWELS "W" TO BE WRAPPED WITH 2 LAYERS OF 15# TAR PAPER, CLOSE FITTING TUBES MADE OF COMPRESSIBLE MATERIAL NOT LESS THAN 1/8" THICK MAY BE SUBSTITUTED.  
 CHAMFER CORNERS 1/4" UNLESS OTHERWISE NOTED.  
 TAR PAPER AND WRAPPINGS TO BE INCLUDED IN PRICE BID FOR CONCRETE.

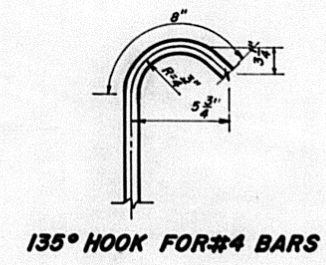
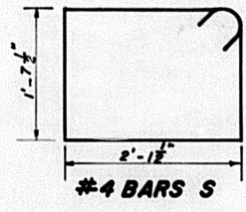
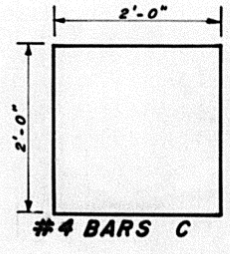
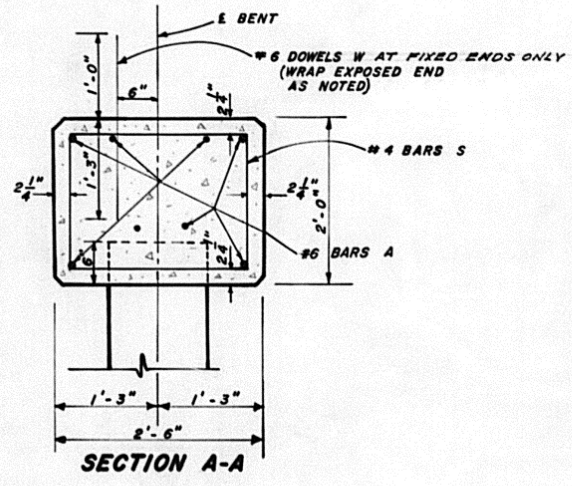

BENTS N#2,3,4,5,6 & 7

**BAYOU TIGRE BRIDGE**  
NEAR  
DEL CAMBRE

DATE: FEB. 11, 1959

STATE OF LOUISIANA  
DEPARTMENT OF HIGHWAYS

|          |         |         |
|----------|---------|---------|
| DESIGNED | BY      | DATE    |
| BY       | BY      | BY      |
| CHECKED  | CHECKED | CHECKED |

BRIDGE DESIGN SECTION

| DATE | DESCRIPTION | BY |
|------|-------------|----|
|      |             |    |
|      |             |    |

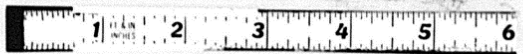

72

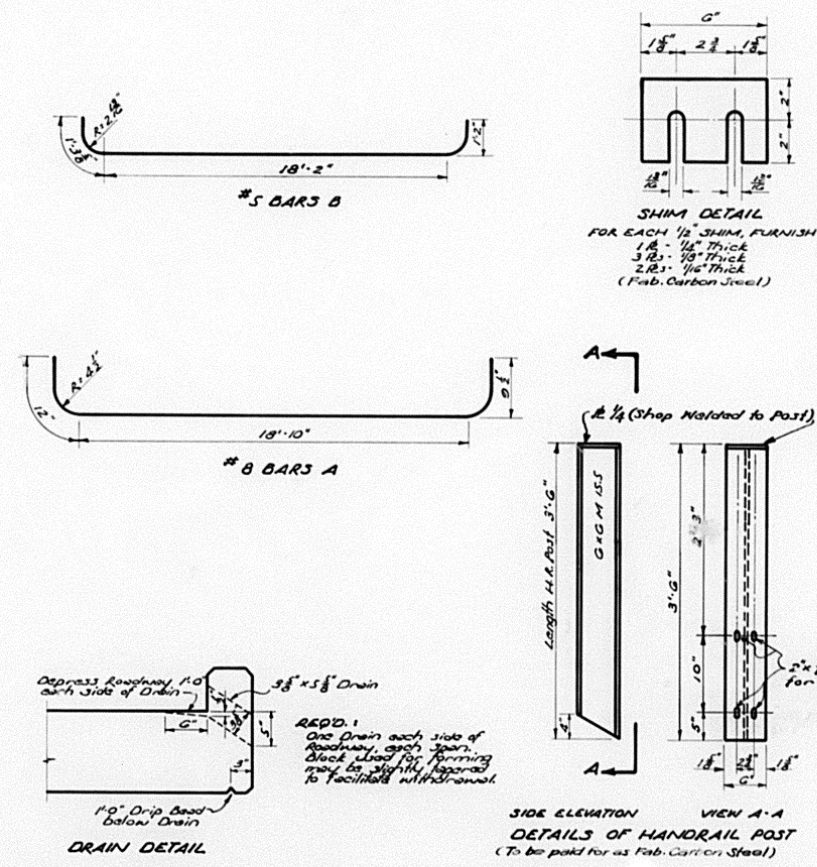
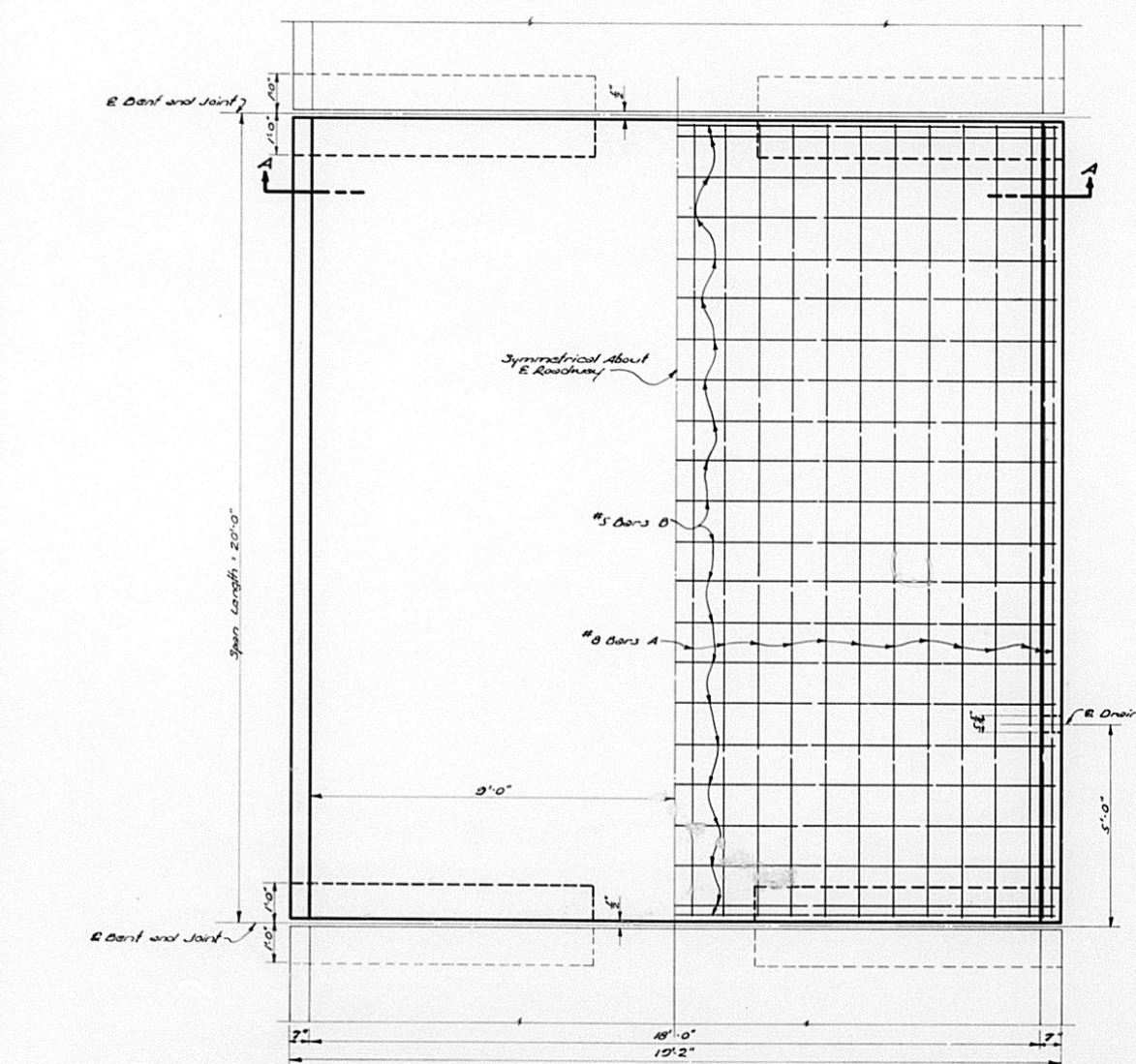
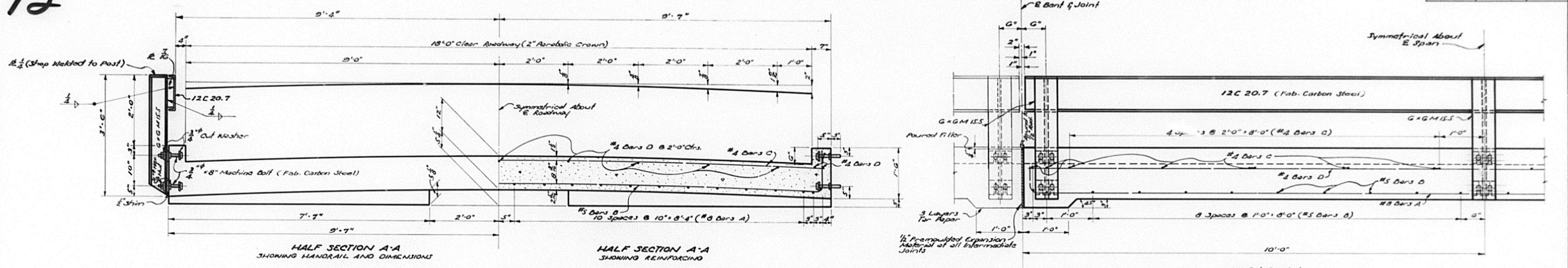

| BILL OF MATERIALS (ONE SPAN)          |      |                |             |              |                |
|---------------------------------------|------|----------------|-------------|--------------|----------------|
| BAR                                   | SIZE | N <sup>o</sup> | UNIT LENGTH | TOTAL LENGTH | LOCATION       |
| A                                     | #8   | 20             | 20'-10"     | 521'-0"      | Bottom of Slab |
| TOTAL #8 BARS = 521'-0" = 12,460 LBS. |      |                |             |              |                |
| B                                     | #5   | 22             | 20'-9"      | 456'-0"      | Bottom of Slab |
| TOTAL #5 BARS = 456'-0" = 4,790 LBS.  |      |                |             |              |                |
| C                                     | #4   | 14             | 18'-8"      | 261'-4"      | Top of Slab    |
| D                                     | #4   | 15             | 15'-8"      | 235'-0"      | Top of Slab    |
| TOTAL #4 BARS = 536'-4" = 372 LBS.    |      |                |             |              |                |
| QUANTITIES (ONE SPAN)                 |      |                |             |              |                |
| TOTAL DEFORMED REINF. STEEL =         |      |                |             | 22,944       | LBS.           |
| TOTAL CLASS "A" CONCRETE =            |      |                |             | 15.06        | CU. YDS.       |
| FAB. CARBON STEEL                     |      |                |             | 1254         | LBS.           |

**GENERAL NOTES:**  
 CONSTRUCTION SPECIFICATIONS: Latest Approved La Dept. of Highways Standards of Specifications.  
 DESIGN SPECIFICATIONS: A.A.S.H.O., 1953, Standard Specifications for Highway Bridges, as amended to Dec. 31, 1955.  
 LIVE LOAD: HS-20.  
 ALL Concrete to be Class "A".  
 Exposed surfaces to have 3/16" chamfer.  
 Reinforcement Bars shall be Intermediate or Hard Grade A.S.T.M. A-15, or Equiv. Steel A.S.T.M. A-15.  
 Dimensions relating to Reinforcing steel are to Bar centers.  
 1/2" Prepacked Expansion Material, Aural Filler, and for Repair to be included in price bid for Concrete.  
 3/16" Bolts, Nuts, Washers, and Shims to be paid for as Fab. Carbon Steel.

SPANS N<sup>o</sup> 1, 2, 3, 4, 8 & 9

**BAYOU TIGRE BRIDGE**  
NEAR  
DEL CAMBRE

DATED FEB. 11 - 1959

STATE OF LOUISIANA  
DEPARTMENT OF HIGHWAYS

|               |                |                    |
|---------------|----------------|--------------------|
| DESIGNED Guy  | DETAILED Guy   | TRACED AND CHECKED |
| CHECKED Nason | CHECKED P. Lee | CHECKED Nason      |

BRIDGE DESIGN SECTION

| DATE | DESCRIPTION | BY |
|------|-------------|----|
|      |             |    |

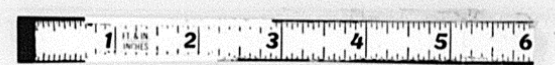

73

|                   |           |           |
|-------------------|-----------|-----------|
| STATE PROJECT NO. | PARISH    | SHEET NO. |
| SBT-08-07         | VERMILION | 12        |

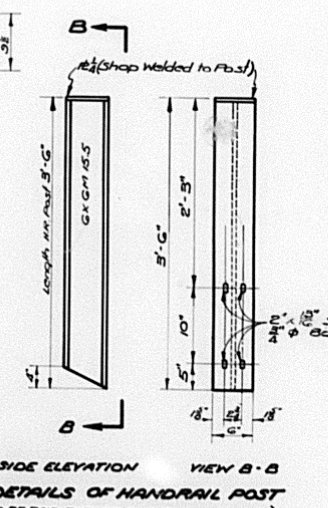
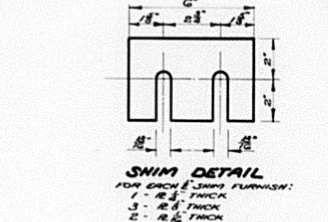
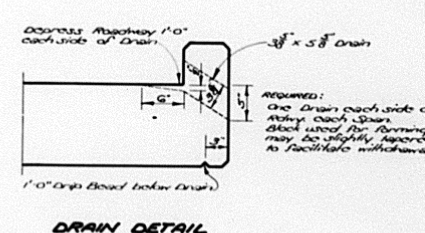
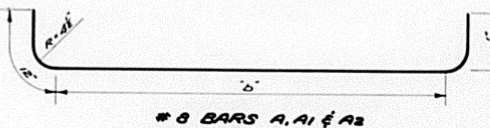
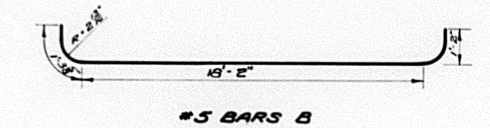
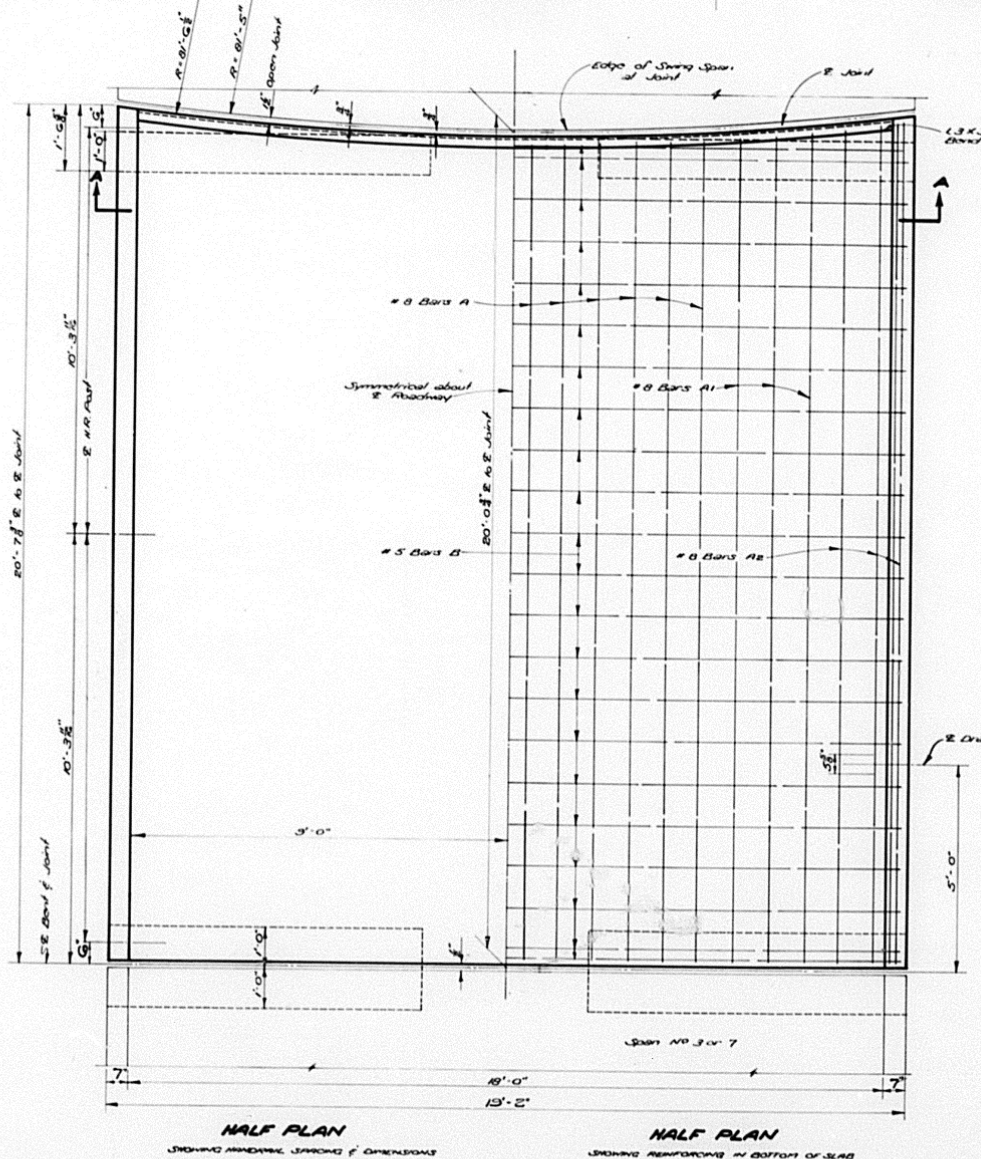
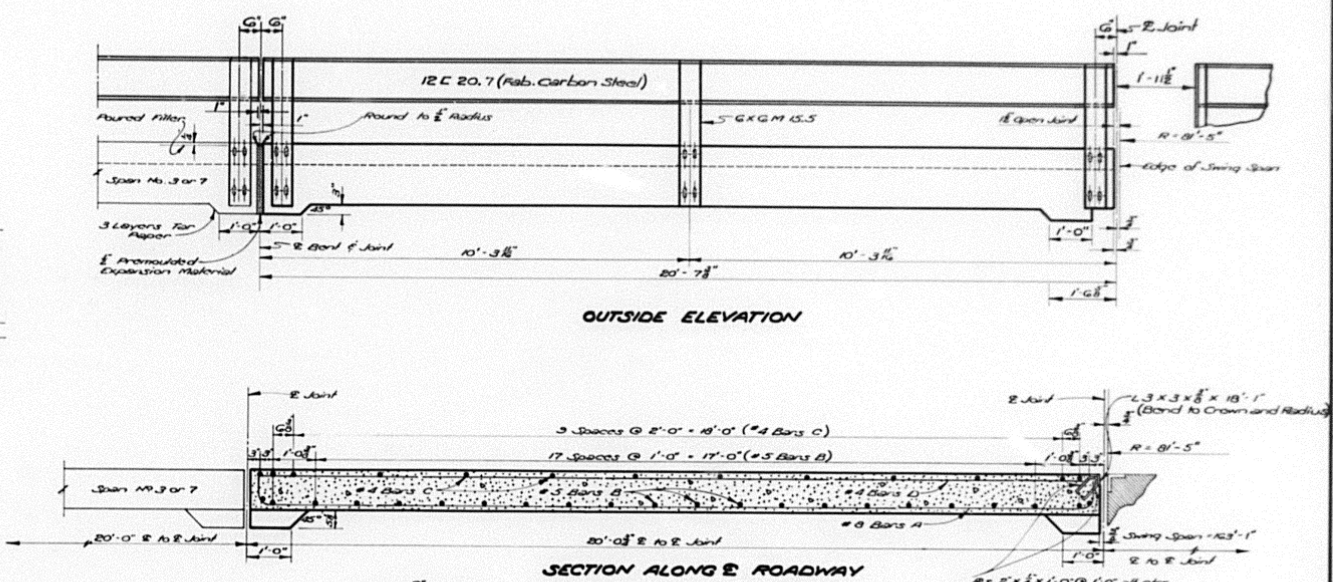
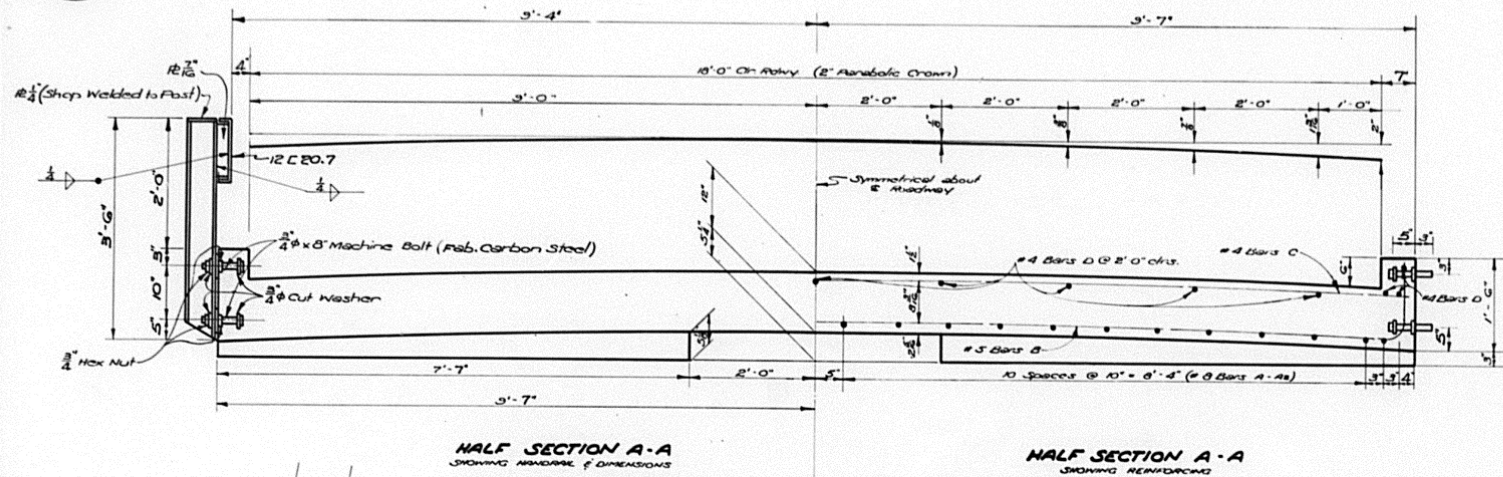

| BILL OF MATERIALS FOR ONE SLAB |      |     |         |                |                |
|--------------------------------|------|-----|---------|----------------|----------------|
| BAR                            | SIZE | NO. | LENGTH  | TOTAL LENGTH   | LOCATION       |
| A                              | #8   | 12  | 20'-10" | 250'-0"        | Bottom of Slab |
| A1                             | #8   | 6   | 21'-1"  | 126'-6"        | Bottom of Slab |
| A2                             | #8   | 8   | 21'-3"  | 170'-0"        | Bottom of Slab |
| TOTAL #8 BARS = 346'-6"        |      |     |         | 1453 LBS.      |                |
| B                              | #5   | 22  | 20'-5"  | 452'-0"        | Bottom of Slab |
| TOTAL #5 BARS = 452'-0"        |      |     |         | 476 LBS.       |                |
| C                              | #4   | 13  | 10'-8"  | 140'-4"        | Top of Slab    |
| D                              | #4   | 15  | 13'-6"  | 204'-0"        | Top of Slab    |
| TOTAL #4 BARS = 288'-0"        |      |     |         | 350 LBS.       |                |
| <b>QUANTITIES</b>              |      |     |         |                |                |
| TOTAL DEF. REINF. STEEL =      |      |     |         | 2294 LBS.      |                |
| CLASS "A" CONCRETE =           |      |     |         | 15.12 CU. YDS. |                |
| FAB. CARBON STEEL =            |      |     |         | 1444 LBS.      |                |

\* Includes End Dam and Handrail.

**GENERAL NOTES:**  
 Construction Specs: Latest Approved to Dept. of Highways, Series Design Specs. A.A.S.H.O. 304 Specs. for any changes as amended to Dec. 31, 1955.  
 Case Load: #15-44  
 All Concrete to be Class "A"  
 Expansion Joints to have 3" Charbon Expansion Joints to have 3" Charbon Reinforcement Bars shall be Intermediate or Hard Grade A.S.T.M. A15 or A17 Steel ASTM A15. Charbon Reinforcing Steel are to be coated with 3" Promulated Expansion Material, Around All; and for paper to be included in price bid for concrete.  
 #8 bolts, nuts, washers, and stems to be paid for as Fab. Carbon Steel.

SPANS #5 & 7

**BAYOU TIGRE BRIDGE**  
NEAR DELCambre

DATED FEB. 11, 1959

STATE OF LOUISIANA  
DEPARTMENT OF HIGHWAYS

|                      |                       |                          |
|----------------------|-----------------------|--------------------------|
| DESIGNED <i>Guy</i>  | DETAILED <i>Guy</i>   | TRACED <i>D. Andrews</i> |
| CHECKED <i>Nolan</i> | CHECKED <i>P. Lee</i> | CHECKED <i>Nolan</i>     |

BRIDGE DESIGN SECTION

| DATE | DESCRIPTION | BY |
|------|-------------|----|
|      | REVISIONS   |    |

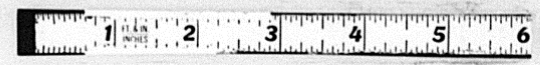

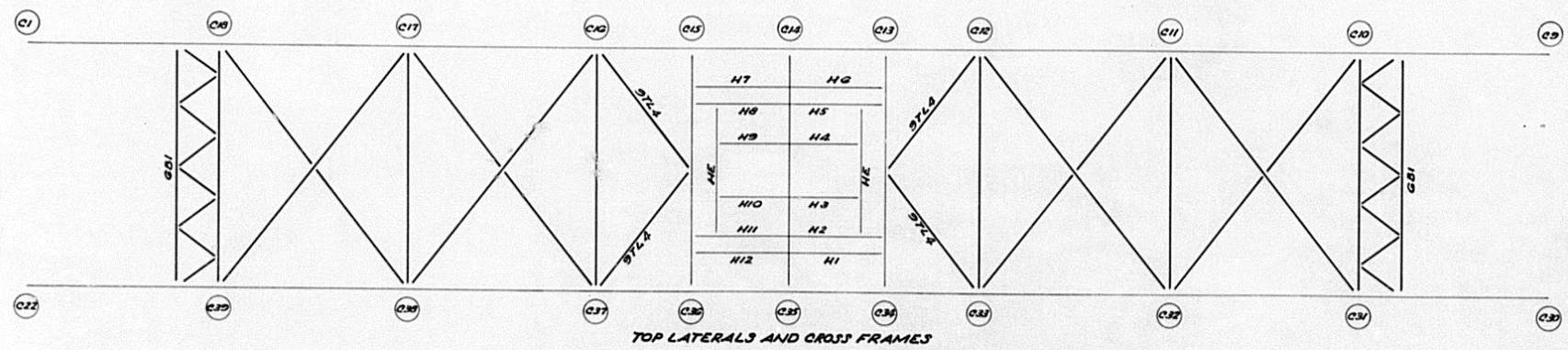
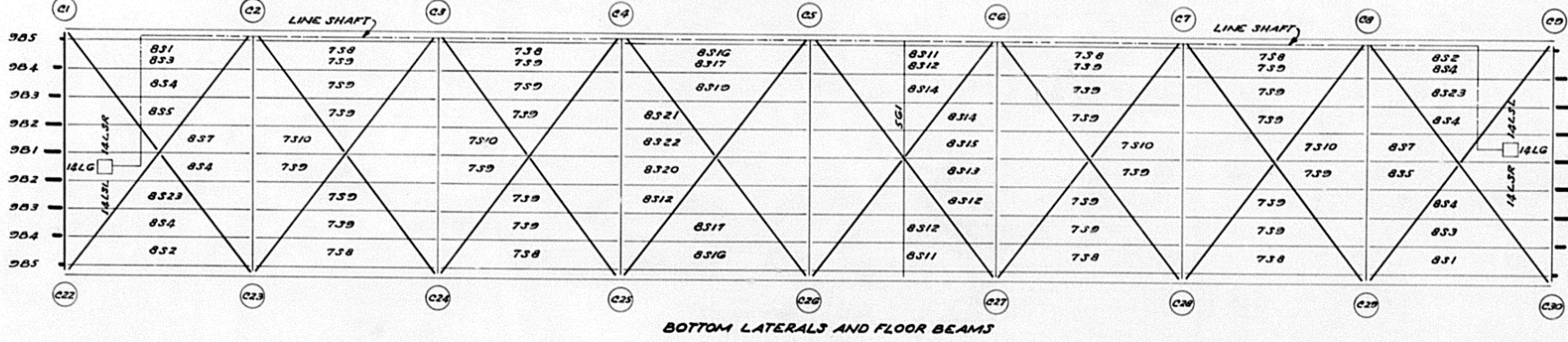
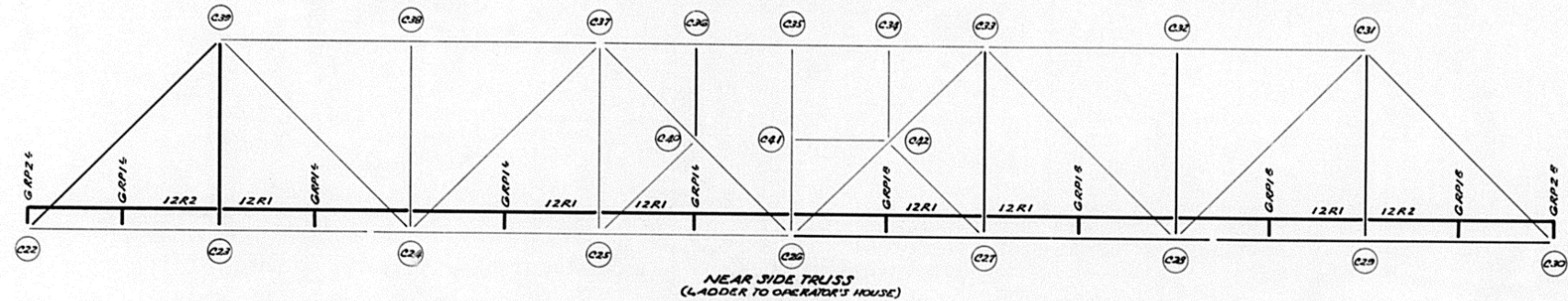
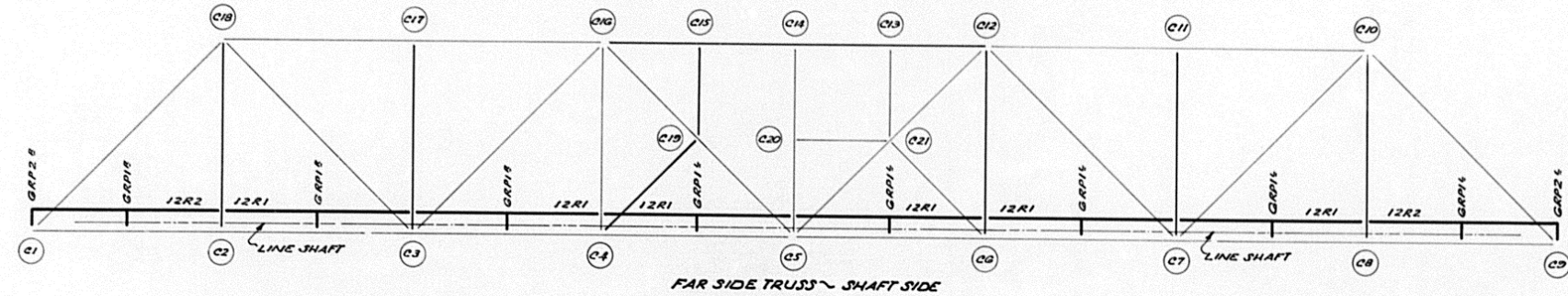

**LEGEND**  
 — GOOD  
 - BENT  
 - TO BE REPLACED

| TRUSS MEMBERS |    |           |           |      |                |          |           |    |       |           |      |                |          |
|---------------|----|-----------|-----------|------|----------------|----------|-----------|----|-------|-----------|------|----------------|----------|
| LOCATION      | N° | MARK      | CONDITION |      |                |          | LOCATION  | N° | MARK  | CONDITION |      |                |          |
|               |    |           | GOOD      | BENT | TO BE REPLACED | SEE NOTE |           |    |       | GOOD      | BENT | TO BE REPLACED | SEE NOTE |
| TOP CHORD     | 1  | C18-C19   | •         |      |                |          | STRINGERS | 4  | 8B4   | •         |      |                |          |
|               | 1  | C19-C20   | •         |      |                |          |           | 4  | 8B5   | •         |      |                |          |
|               | 1  | C20-C21   | •         |      |                |          |           | 2  | 8B1   | •         |      |                |          |
|               | 1  | C21-C22   | •         |      |                |          |           | 2  | 8B2   | •         |      |                |          |
|               | 1  | C22-C23   | •         |      |                |          |           | 2  | 8B3   | •         |      |                |          |
| BOT. CHORD    | 1  | C1-C2     | •         |      |                |          |           | 2  | 8B4   | •         |      |                |          |
|               | 1  | C2-C3     | •         |      |                |          |           | 2  | 8B5   | •         |      |                |          |
|               | 1  | C3-C4     | •         |      |                |          |           | 2  | 8B6   | •         |      |                |          |
|               | 1  | C4-C5     | •         |      |                |          |           | 2  | 8B7   | •         |      |                |          |
|               | 1  | C5-C6     | •         |      |                |          |           | 2  | 8B8   | •         |      |                |          |
|               | 1  | C6-C7     | •         |      |                |          |           | 2  | 8B9   | •         |      |                |          |
|               | 1  | C7-C8     | •         |      |                |          |           | 2  | 8B10  | •         |      |                |          |
|               | 1  | C8-C9     | •         |      |                |          |           | 2  | 8B11  | •         |      |                |          |
|               | 1  | C9-C10    | •         |      |                |          |           | 2  | 8B12  | •         |      |                |          |
|               | 1  | C10-C11   | •         |      |                |          |           | 2  | 8B13  | •         |      |                |          |
|               | 1  | C11-C12   | •         |      |                |          |           | 2  | 8B14  | •         |      |                |          |
|               | 1  | C12-C13   | •         |      |                |          |           | 2  | 8B15  | •         |      |                |          |
|               | 1  | C13-C14   | •         |      |                |          |           | 2  | 8B16  | •         |      |                |          |
|               | 1  | C14-C15   | •         |      |                |          |           | 2  | 8B17  | •         |      |                |          |
|               | 1  | C15-C16   | •         |      |                |          |           | 2  | 8B18  | •         |      |                |          |
|               | 1  | C16-C17   | •         |      |                |          |           | 2  | 8B19  | •         |      |                |          |
|               | 1  | C17-C18   | •         |      |                |          |           | 2  | 8B20  | •         |      |                |          |
|               | 1  | C18-C19   | •         |      |                |          |           | 2  | 8B21  | •         |      |                |          |
|               | 1  | C19-C20   | •         |      |                |          |           | 2  | 8B22  | •         |      |                |          |
|               | 1  | C20-C21   | •         |      |                |          |           | 2  | 8B23  | •         |      |                |          |
|               | 1  | C21-C22   | •         |      |                |          |           | 2  | 8B24  | •         |      |                |          |
|               | 1  | C22-C23   | •         |      |                |          |           | 2  | 8B25  | •         |      |                |          |
|               | 1  | C23-C24   | •         |      |                |          |           | 2  | 8B26  | •         |      |                |          |
|               | 1  | C24-C25   | •         |      |                |          |           | 2  | 8B27  | •         |      |                |          |
|               | 1  | C25-C26   | •         |      |                |          |           | 2  | 8B28  | •         |      |                |          |
|               | 1  | C26-C27   | •         |      |                |          |           | 2  | 8B29  | •         |      |                |          |
|               | 1  | C27-C28   | •         |      |                |          |           | 2  | 8B30  | •         |      |                |          |
|               | 1  | C28-C29   | •         |      |                |          |           | 2  | 8B31  | •         |      |                |          |
|               | 1  | C29-C30   | •         |      |                |          |           | 2  | 8B32  | •         |      |                |          |
|               | 1  | C30-C31   | •         |      |                |          |           | 2  | 8B33  | •         |      |                |          |
|               | 1  | C31-C32   | •         |      |                |          |           | 2  | 8B34  | •         |      |                |          |
|               | 1  | C32-C33   | •         |      |                |          |           | 2  | 8B35  | •         |      |                |          |
|               | 1  | C33-C34   | •         |      |                |          |           | 2  | 8B36  | •         |      |                |          |
|               | 1  | C34-C35   | •         |      |                |          |           | 2  | 8B37  | •         |      |                |          |
|               | 1  | C35-C36   | •         |      |                |          |           | 2  | 8B38  | •         |      |                |          |
|               | 1  | C36-C37   | •         |      |                |          |           | 2  | 8B39  | •         |      |                |          |
|               | 1  | C37-C38   | •         |      |                |          |           | 2  | 8B40  | •         |      |                |          |
|               | 1  | C38-C39   | •         |      |                |          |           | 2  | 8B41  | •         |      |                |          |
|               | 1  | C39-C40   | •         |      |                |          |           | 2  | 8B42  | •         |      |                |          |
|               | 1  | C40-C41   | •         |      |                |          |           | 2  | 8B43  | •         |      |                |          |
|               | 1  | C41-C42   | •         |      |                |          |           | 2  | 8B44  | •         |      |                |          |
|               | 1  | C42-C43   | •         |      |                |          |           | 2  | 8B45  | •         |      |                |          |
|               | 1  | C43-C44   | •         |      |                |          |           | 2  | 8B46  | •         |      |                |          |
|               | 1  | C44-C45   | •         |      |                |          |           | 2  | 8B47  | •         |      |                |          |
|               | 1  | C45-C46   | •         |      |                |          |           | 2  | 8B48  | •         |      |                |          |
|               | 1  | C46-C47   | •         |      |                |          |           | 2  | 8B49  | •         |      |                |          |
|               | 1  | C47-C48   | •         |      |                |          |           | 2  | 8B50  | •         |      |                |          |
|               | 1  | C48-C49   | •         |      |                |          |           | 2  | 8B51  | •         |      |                |          |
|               | 1  | C49-C50   | •         |      |                |          |           | 2  | 8B52  | •         |      |                |          |
|               | 1  | C50-C51   | •         |      |                |          |           | 2  | 8B53  | •         |      |                |          |
|               | 1  | C51-C52   | •         |      |                |          |           | 2  | 8B54  | •         |      |                |          |
|               | 1  | C52-C53   | •         |      |                |          |           | 2  | 8B55  | •         |      |                |          |
|               | 1  | C53-C54   | •         |      |                |          |           | 2  | 8B56  | •         |      |                |          |
|               | 1  | C54-C55   | •         |      |                |          |           | 2  | 8B57  | •         |      |                |          |
|               | 1  | C55-C56   | •         |      |                |          |           | 2  | 8B58  | •         |      |                |          |
|               | 1  | C56-C57   | •         |      |                |          |           | 2  | 8B59  | •         |      |                |          |
|               | 1  | C57-C58   | •         |      |                |          |           | 2  | 8B60  | •         |      |                |          |
|               | 1  | C58-C59   | •         |      |                |          |           | 2  | 8B61  | •         |      |                |          |
|               | 1  | C59-C60   | •         |      |                |          |           | 2  | 8B62  | •         |      |                |          |
|               | 1  | C60-C61   | •         |      |                |          |           | 2  | 8B63  | •         |      |                |          |
|               | 1  | C61-C62   | •         |      |                |          |           | 2  | 8B64  | •         |      |                |          |
|               | 1  | C62-C63   | •         |      |                |          |           | 2  | 8B65  | •         |      |                |          |
|               | 1  | C63-C64   | •         |      |                |          |           | 2  | 8B66  | •         |      |                |          |
|               | 1  | C64-C65   | •         |      |                |          |           | 2  | 8B67  | •         |      |                |          |
|               | 1  | C65-C66   | •         |      |                |          |           | 2  | 8B68  | •         |      |                |          |
|               | 1  | C66-C67   | •         |      |                |          |           | 2  | 8B69  | •         |      |                |          |
|               | 1  | C67-C68   | •         |      |                |          |           | 2  | 8B70  | •         |      |                |          |
|               | 1  | C68-C69   | •         |      |                |          |           | 2  | 8B71  | •         |      |                |          |
|               | 1  | C69-C70   | •         |      |                |          |           | 2  | 8B72  | •         |      |                |          |
|               | 1  | C70-C71   | •         |      |                |          |           | 2  | 8B73  | •         |      |                |          |
|               | 1  | C71-C72   | •         |      |                |          |           | 2  | 8B74  | •         |      |                |          |
|               | 1  | C72-C73   | •         |      |                |          |           | 2  | 8B75  | •         |      |                |          |
|               | 1  | C73-C74   | •         |      |                |          |           | 2  | 8B76  | •         |      |                |          |
|               | 1  | C74-C75   | •         |      |                |          |           | 2  | 8B77  | •         |      |                |          |
|               | 1  | C75-C76   | •         |      |                |          |           | 2  | 8B78  | •         |      |                |          |
|               | 1  | C76-C77   | •         |      |                |          |           | 2  | 8B79  | •         |      |                |          |
|               | 1  | C77-C78   | •         |      |                |          |           | 2  | 8B80  | •         |      |                |          |
|               | 1  | C78-C79   | •         |      |                |          |           | 2  | 8B81  | •         |      |                |          |
|               | 1  | C79-C80   | •         |      |                |          |           | 2  | 8B82  | •         |      |                |          |
|               | 1  | C80-C81   | •         |      |                |          |           | 2  | 8B83  | •         |      |                |          |
|               | 1  | C81-C82   | •         |      |                |          |           | 2  | 8B84  | •         |      |                |          |
|               | 1  | C82-C83   | •         |      |                |          |           | 2  | 8B85  | •         |      |                |          |
|               | 1  | C83-C84   | •         |      |                |          |           | 2  | 8B86  | •         |      |                |          |
|               | 1  | C84-C85   | •         |      |                |          |           | 2  | 8B87  | •         |      |                |          |
|               | 1  | C85-C86   | •         |      |                |          |           | 2  | 8B88  | •         |      |                |          |
|               | 1  | C86-C87   | •         |      |                |          |           | 2  | 8B89  | •         |      |                |          |
|               | 1  | C87-C88   | •         |      |                |          |           | 2  | 8B90  | •         |      |                |          |
|               | 1  | C88-C89   | •         |      |                |          |           | 2  | 8B91  | •         |      |                |          |
|               | 1  | C89-C90   | •         |      |                |          |           | 2  | 8B92  | •         |      |                |          |
|               | 1  | C90-C91   | •         |      |                |          |           | 2  | 8B93  | •         |      |                |          |
|               | 1  | C91-C92   | •         |      |                |          |           | 2  | 8B94  | •         |      |                |          |
|               | 1  | C92-C93   | •         |      |                |          |           | 2  | 8B95  | •         |      |                |          |
|               | 1  | C93-C94   | •         |      |                |          |           | 2  | 8B96  | •         |      |                |          |
|               | 1  | C94-C95   | •         |      |                |          |           | 2  | 8B97  | •         |      |                |          |
|               | 1  | C95-C96   | •         |      |                |          |           | 2  | 8B98  | •         |      |                |          |
|               | 1  | C96-C97   | •         |      |                |          |           | 2  | 8B99  | •         |      |                |          |
|               | 1  | C97-C98   | •         |      |                |          |           | 2  | 8B100 | •         |      |                |          |
|               | 1  | C98-C99   | •         |      |                |          |           | 2  | 8B101 | •         |      |                |          |
|               | 1  | C99-C100  | •         |      |                |          |           | 2  | 8B102 | •         |      |                |          |
|               | 1  | C100-C101 | •         |      |                |          |           | 2  | 8B103 | •         |      |                |          |
|               | 1  | C101-C102 | •         |      |                |          |           | 2  | 8B104 | •         |      |                |          |
|               | 1  | C102-C103 | •         |      |                |          |           | 2  | 8B105 | •         |      |                |          |
|               | 1  | C103-C104 | •         |      |                |          |           | 2  | 8B106 | •         |      |                |          |
|               | 1  | C104-C105 | •         |      |                |          |           | 2  | 8B107 | •         |      |                |          |
|               | 1  | C105-C106 | •         |      |                |          |           | 2  | 8B108 | •         |      |                |          |
|               | 1  | C106-C107 | •         |      |                |          |           | 2  | 8B109 | •         |      |                |          |
|               | 1  | C107-C108 | •         |      |                |          |           | 2  | 8B110 | •         |      |                |          |
|               | 1  | C108-C109 | •         |      |                |          |           | 2  | 8B111 | •         |      |                |          |
|               | 1  | C109-C110 | •         |      |                |          |           | 2  | 8B112 | •         |      |                |          |
|               | 1  | C110-C111 | •         |      |                |          |           | 2  | 8B113 | •         |      |                |          |
|               | 1  | C111-C112 | •         |      |                |          |           | 2  | 8B114 | •         |      |                |          |
|               | 1  | C112-C113 | •         |      |                |          |           | 2  | 8B115 | •         |      |                |          |
|               | 1  | C113-C114 | •         |      |                |          |           | 2  | 8B116 | •         |      |                |          |
|               | 1  | C114-C115 | •         |      |                |          |           | 2  | 8B117 | •         |      |                |          |
|               | 1  | C115-C116 | •         |      |                |          |           | 2  | 8B118 | •         |      |                |          |
|               | 1  | C116-C117 | •         |      |                |          |           |    |       |           |      |                |          |

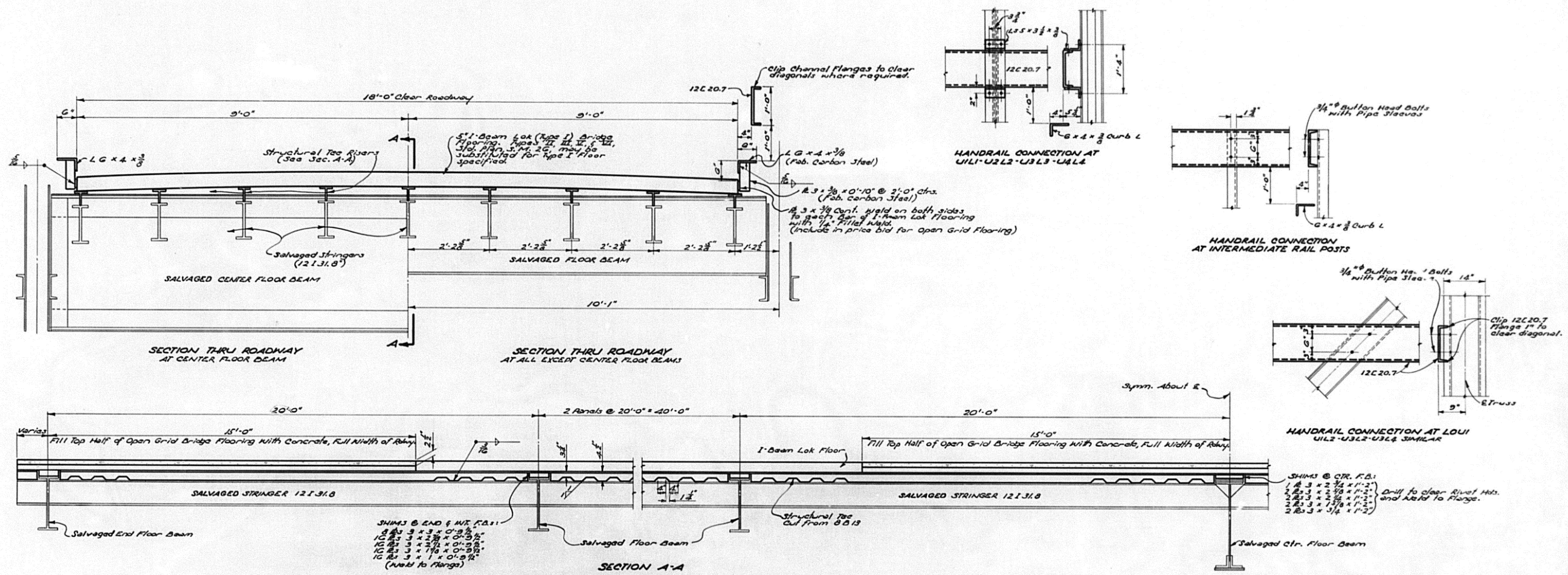

**\* ESTIMATED QUANTITIES**

|                           |       |          |
|---------------------------|-------|----------|
| OPEN GRID BRIDGE FLOORING | 2921  | SP. FT.  |
| FABRICATED CARBON STEEL   | 15470 | LBS.     |
| CLASS "Y" CONCRETE        | 7.55  | CU. YDS. |

\* Handrail not included in these quantities. Handrail quantities included in Fab. Carbon Steel on Sheet No. 13.

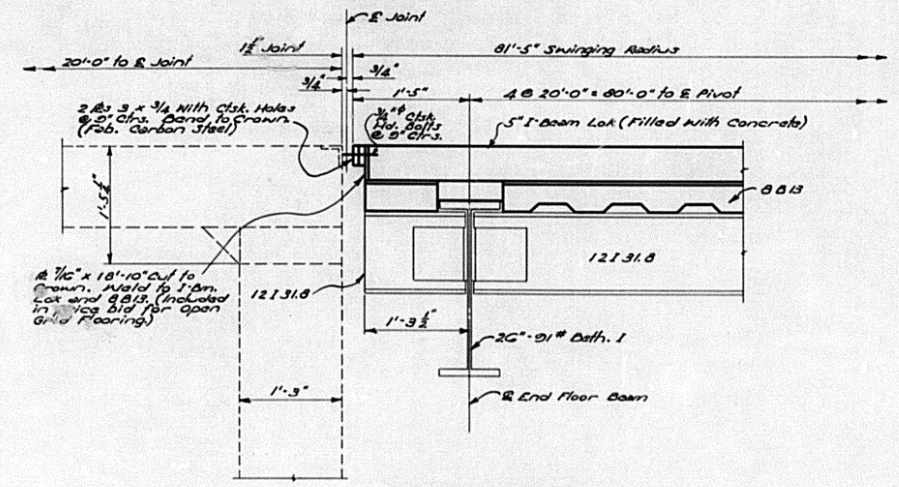

**SPAN #6 DECKING DETAILS**

**BAYOU TIGRE BRIDGE**  
NEAR DELCAMBRE

DATED FEB. 11, 1959

STATE OF LOUISIANA  
DEPARTMENT OF HIGHWAYS

|          |        |              |
|----------|--------|--------------|
| DESIGNED | TRACED | AR. MONCRIEF |
| CHECKED  | BY     |              |

BRIDGE DESIGN SECTION

| DATE | DESCRIPTION | BY |
|------|-------------|----|
|      | REVISIONS   |    |

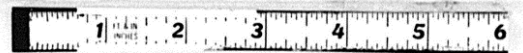

77

|               |           |           |
|---------------|-----------|-----------|
| STATE PROJECT | PARISH    | SHEET NO. |
| 397-03-07     | VERMILION | 76        |

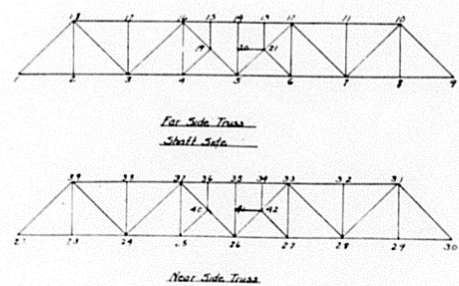
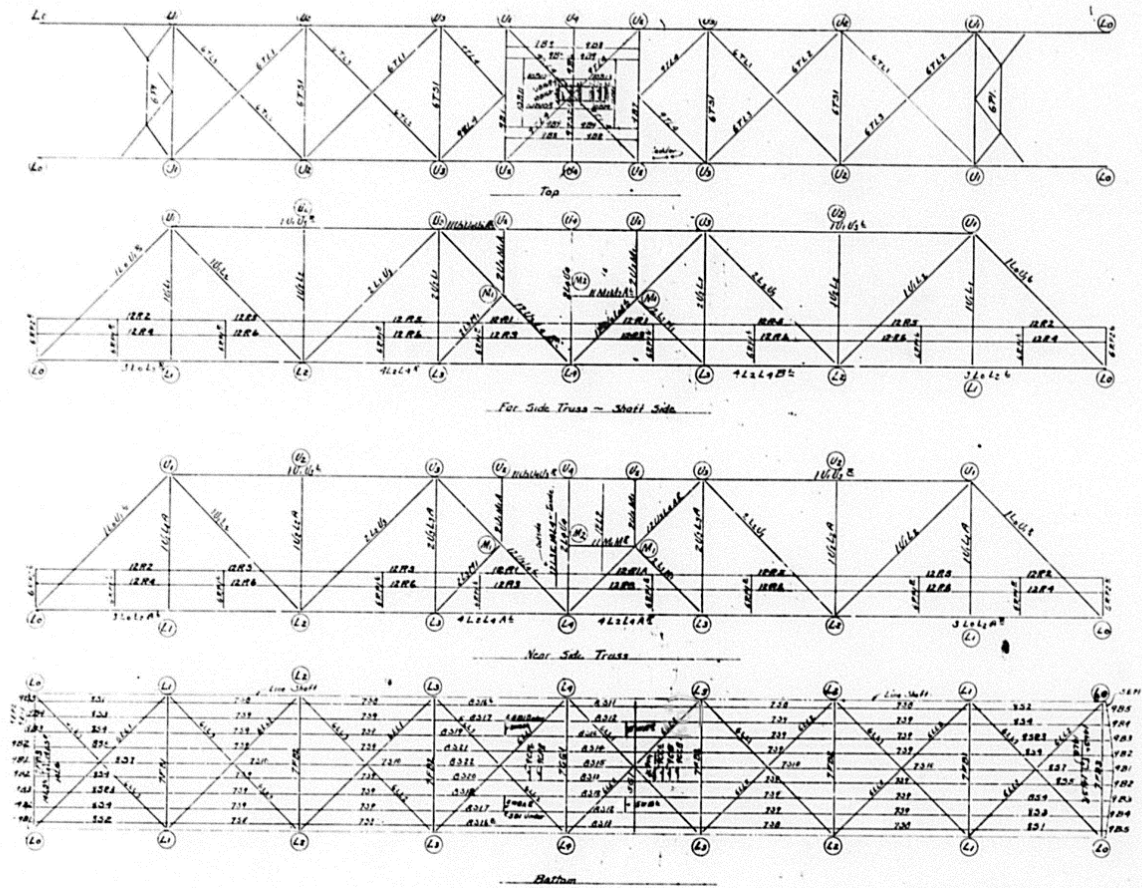

MATCH MARKING DIAGRAMS

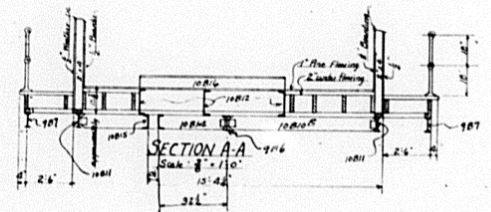
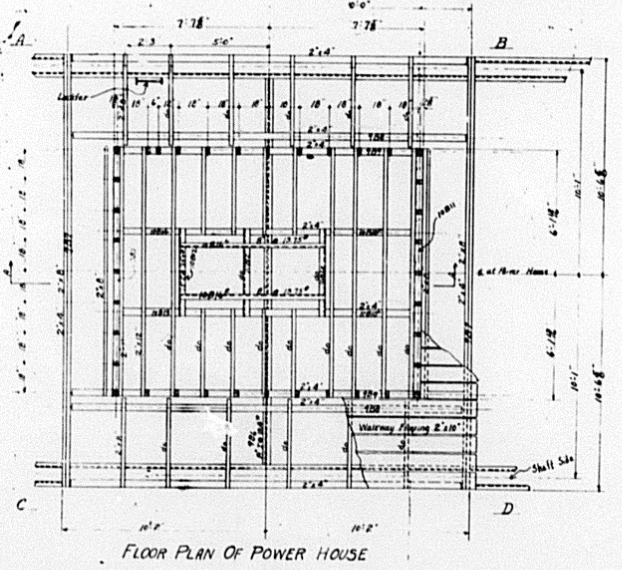
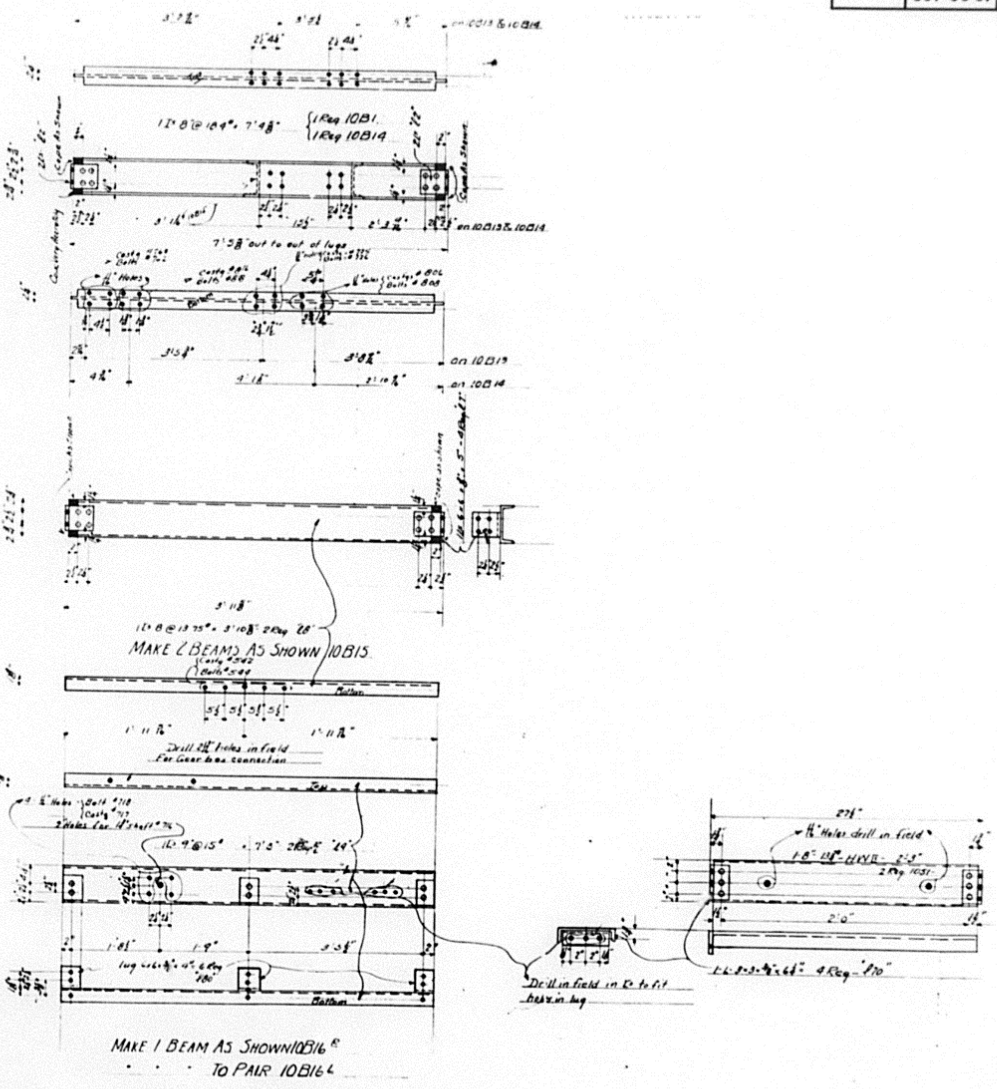
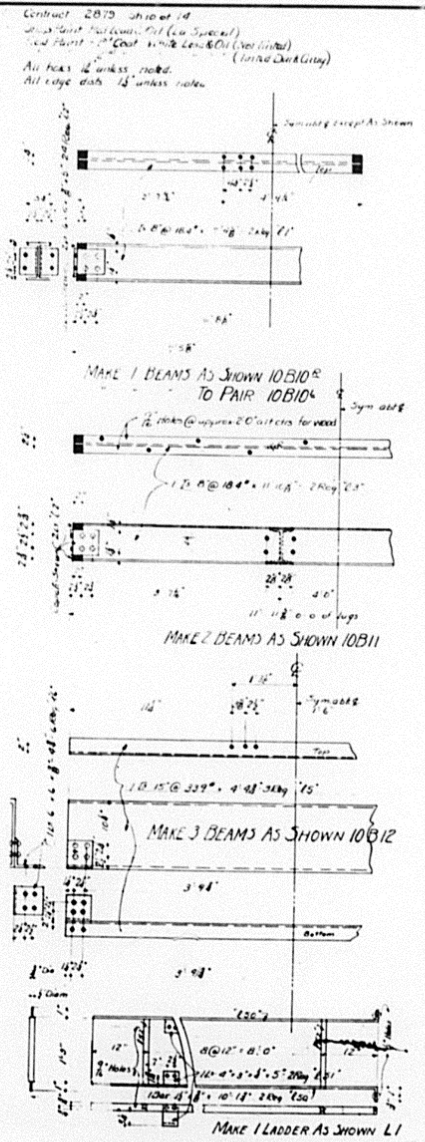

REPRODUCTIONS  
 OF ORIGINAL  
 STRUCTURAL SHOP DRAWINGS  
 BY  
 VINCENNES BRIDGE CO.  
 FOR  
 160' SWING SPAN

**BAYOU TIGRE BRIDGE**  
 NEAR  
 DELCambre

DATED APRIL 14, 1959

STATE OF LOUISIANA  
 DEPARTMENT OF HIGHWAYS

|          |             |
|----------|-------------|
| DESIGNED | TRACED      |
| CHECKED  | CHECKED     |
| DATE     | DESCRIPTION |
| BY       | REVISIONS   |

BRIDGE DESIGN SECTION

SHEET 1 OF 8

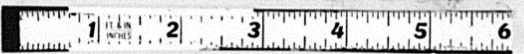

85

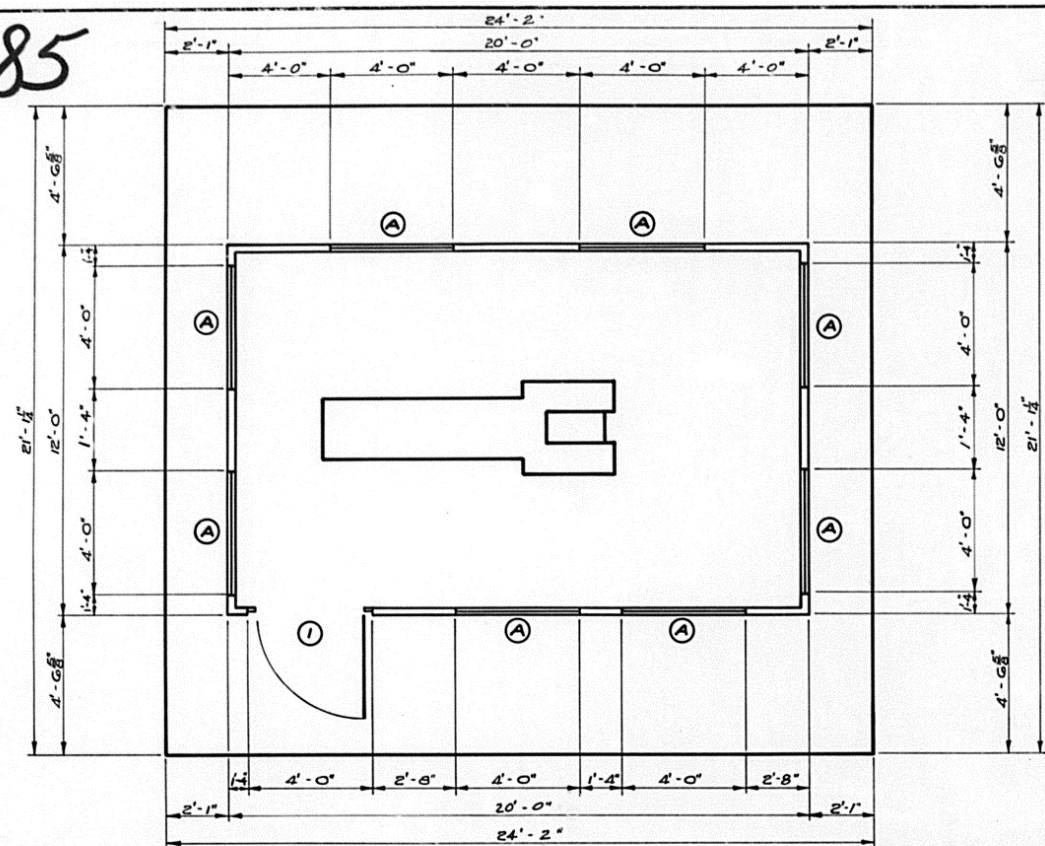

FLOOR PLAN

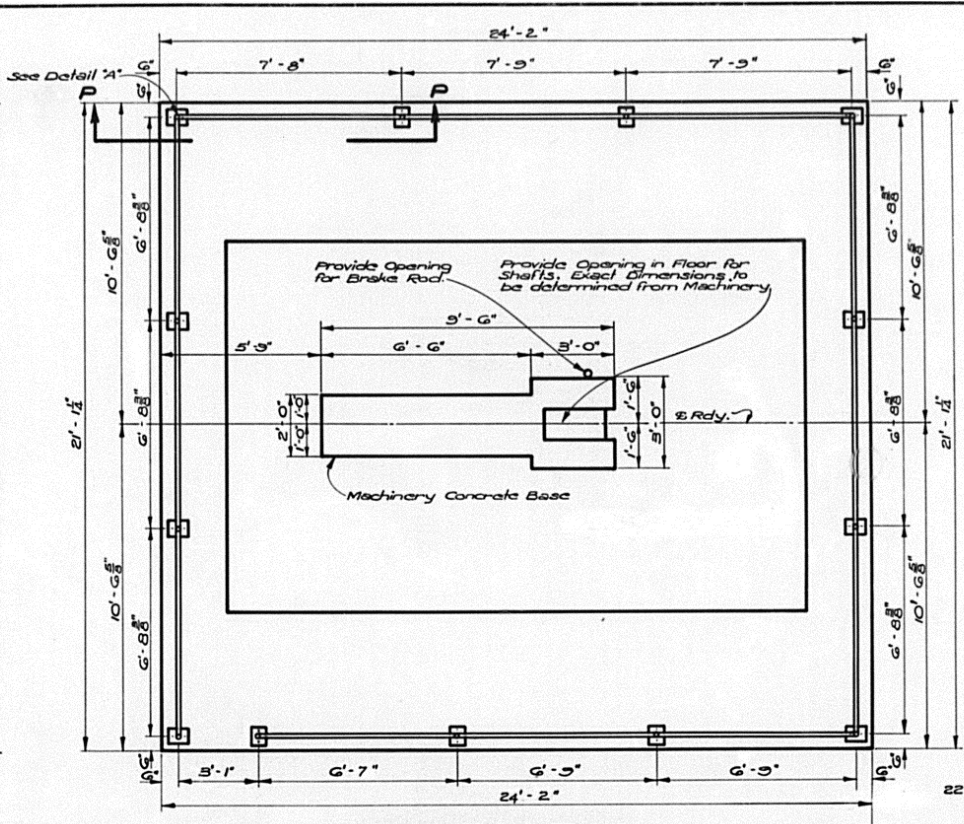

FOUNDATION PLAN  
SEE BUILDING MANUFACTURER'S PLANS FOR ANCHOR BOLT LOCATIONS

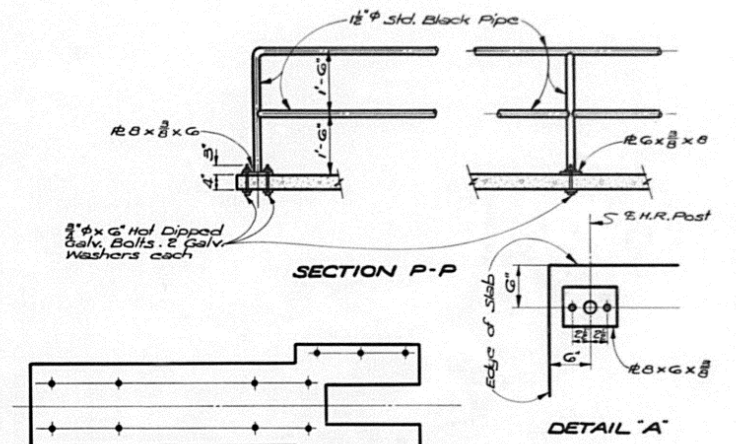

ANCHOR BOLT PLAN FOR MACHINERY BASE  
(EXACT LOCATION TO BE MADE FROM APPROVED MACHINERY DRAWING)

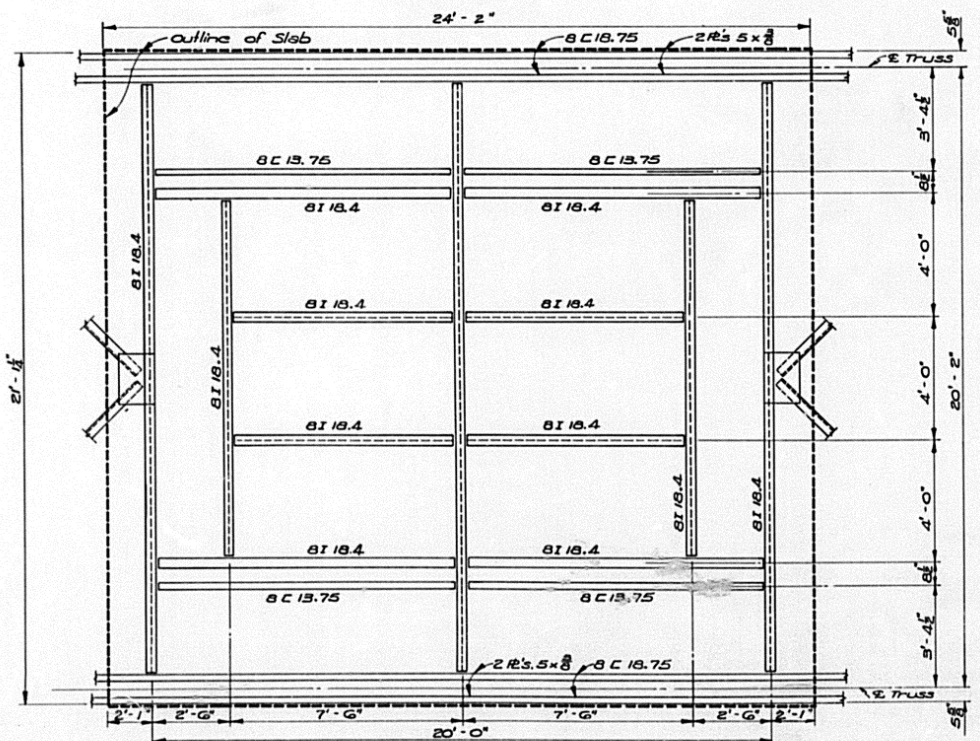

FOUNDATION PLAN  
SHOWING SUB STRUCTURE

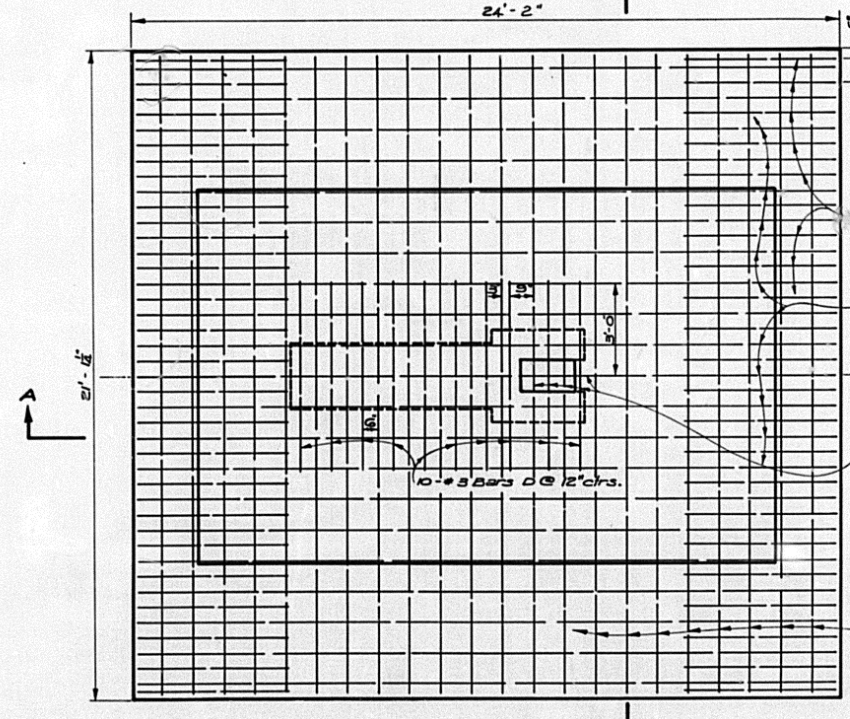

FOUNDATION PLAN  
SHOWING REINFORCING STEEL

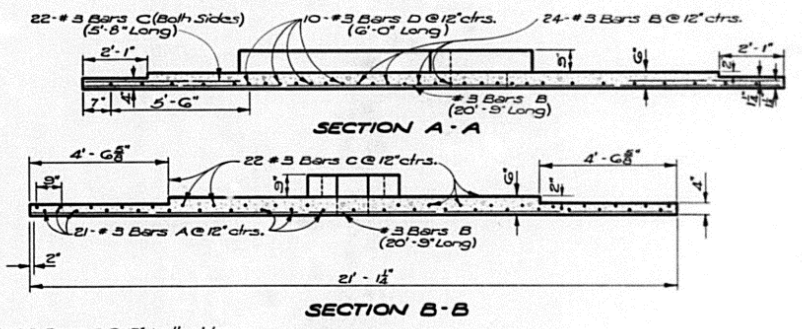

| BAR SCHEDULE                       |    |        |              |         |
|------------------------------------|----|--------|--------------|---------|
| BAR SIZE                           | Nº | LENGTH | TOTAL LENGTH |         |
| A                                  | #3 | 21     | 23'-10"      | 500'-6" |
| B                                  | #3 | 24     | 20'-9"       | 498'-0" |
| C                                  | #3 | 44     | 5'-8"        | 243'-4" |
| D                                  | #3 | 10     | 6'-0"        | 60'-0"  |
| TOTAL #3 BARS = 107-10" = 432 LBS. |    |        |              |         |
| CLASS Y CONCRETE = 8.16 CU YD.     |    |        |              |         |

OPERATING HOUSE

BAYOU TIGRE BRIDGE  
NEAR  
DELCAMBRE

DATED Feb. 23, 1959

STATE OF LOUISIANA  
DEPARTMENT OF HIGHWAYS

|                        |                        |                       |
|------------------------|------------------------|-----------------------|
| DESIGNED <i>Anders</i> | DETAILED <i>Anders</i> | TRACED <i>Anders</i>  |
| CHECKED <i>Anders</i>  | CHECKED <i>Anders</i>  | CHECKED <i>Anders</i> |
| BRIDGE DESIGN SECTION  |                        |                       |

SHEET 1 OF 2

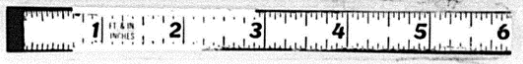

95

|               |           |       |
|---------------|-----------|-------|
| STATE PROJECT | PARISH    | SHEET |
| 397-03-C7     | VERMILION | 34    |

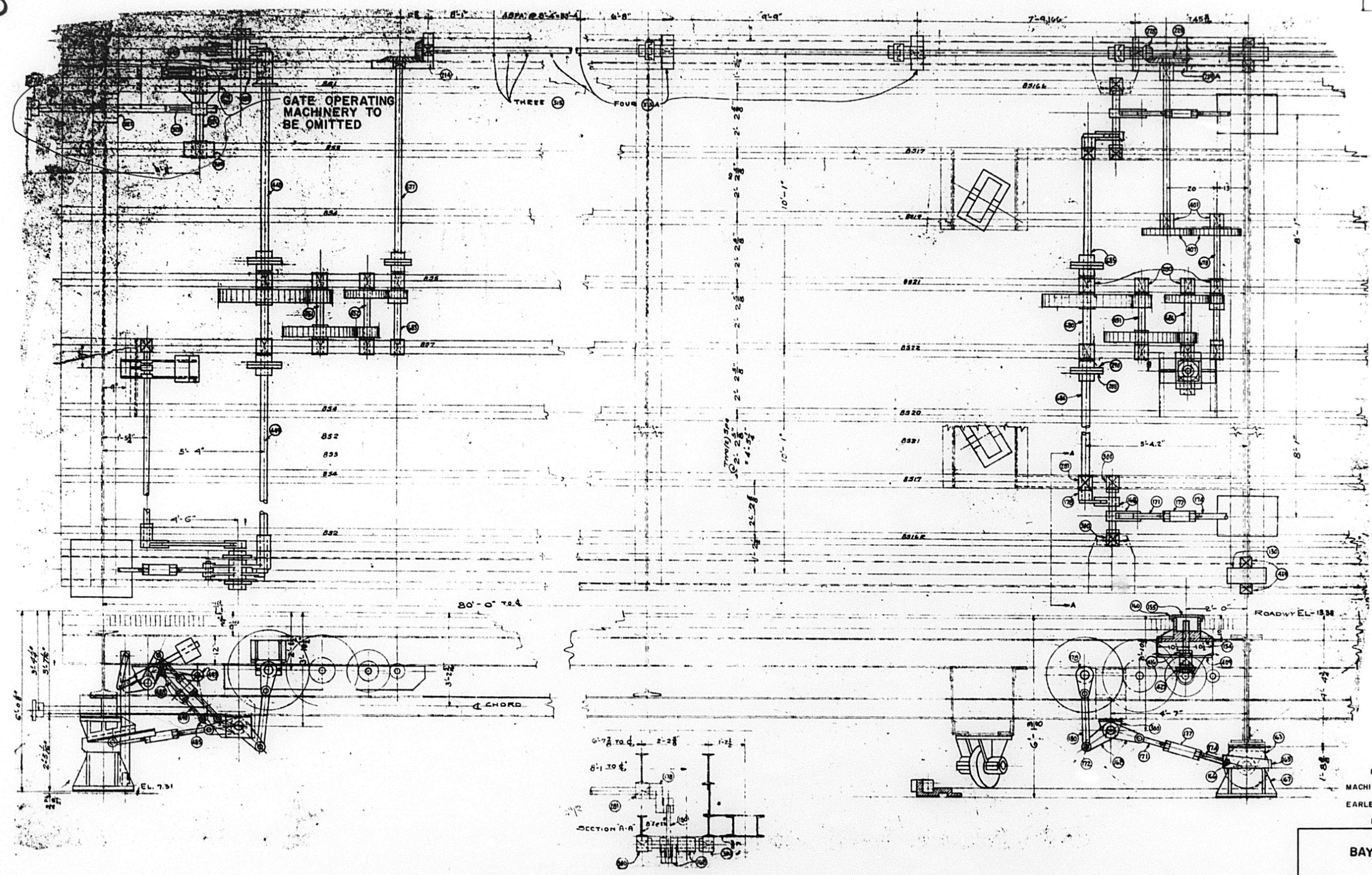

REPRODUCTIONS  
OF ORIGINAL  
MACHINERY SHOP DRAWINGS  
BY  
EARLE GEAR & MACHINE CO.  
FOR  
160' SWING SPAN

M3

**BAYOU TIGRE BRIDGE**  
NEAR  
DELCAMBRE

DATED APRIL 14, 1959

STATE OF LOUISIANA  
DEPARTMENT OF HIGHWAYS

| DATE      | DESCRIPTION | BY | DESIGNED              | Detailed | Tracked |
|-----------|-------------|----|-----------------------|----------|---------|
|           |             |    | CHECKED               | CHECKED  | CHECKED |
| REVISIONS |             |    | BRIDGE DESIGN SECTION |          |         |

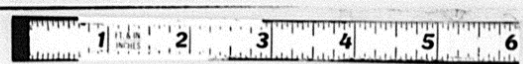



96

|               |           |       |
|---------------|-----------|-------|
| STATE PROJECT | PARISH    | SHEET |
| 397-03-07     | VERMILION | 35    |

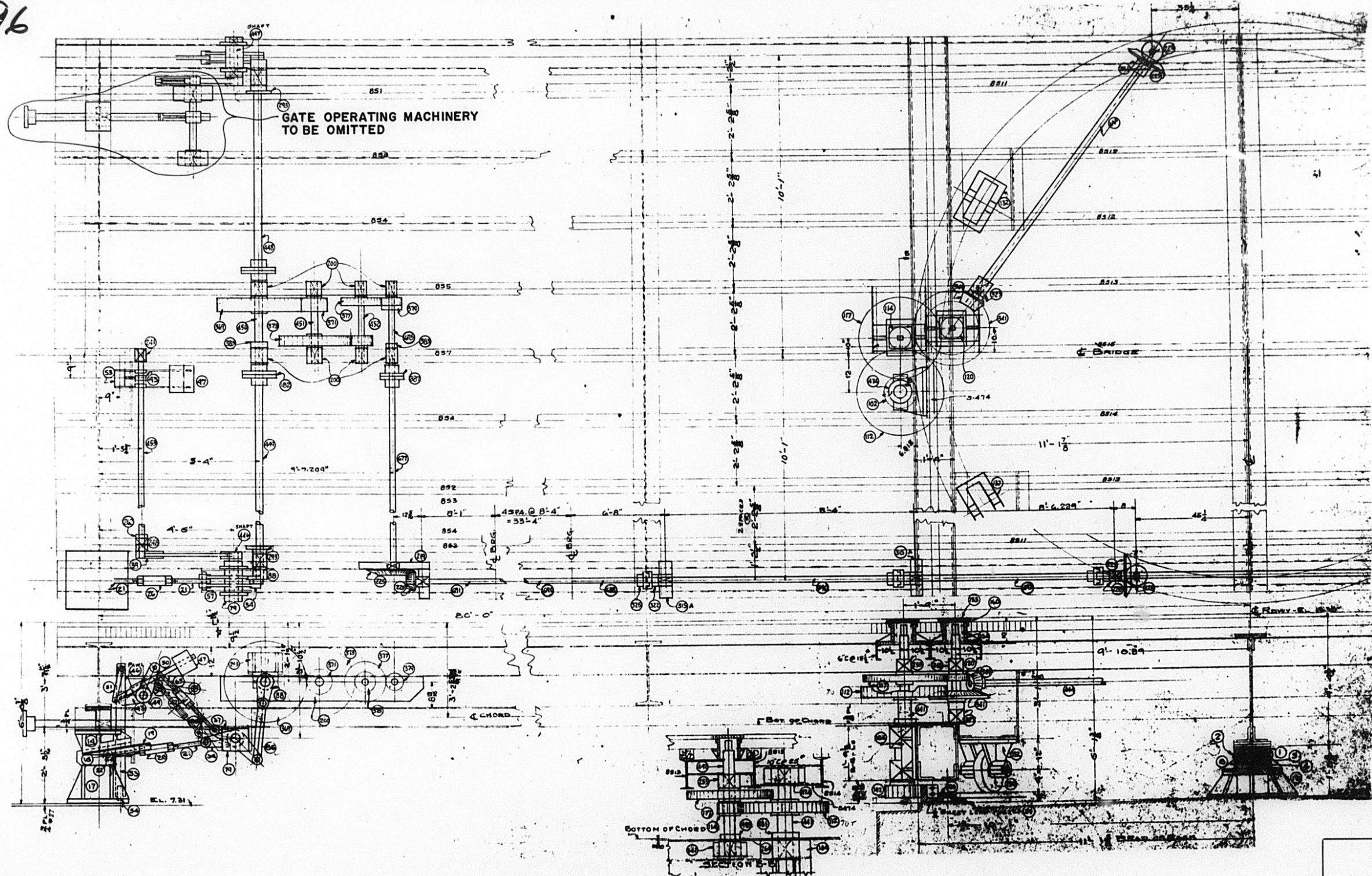

REPRODUCTIONS  
OF ORIGINAL  
MACHINERY SHOP DRAWINGS  
BY  
EARLE GEAR & MACHINE CO.  
FOR  
160' SWING SPAN

**M4**

**BAYOU TIGRE BRIDGE**  
NEAR  
DELCAMBRE

DATED APRIL 14, 1959

STATE OF LOUISIANA  
DEPARTMENT OF HIGHWAYS

|          |          |         |
|----------|----------|---------|
| DESIGNED | DETAILED | TRACED  |
| CHECKED  | CHECKED  | CHECKED |

BRIDGE DESIGN SECTION

| DATE | DESCRIPTION | BY |
|------|-------------|----|
|      | REVISIONS   |    |

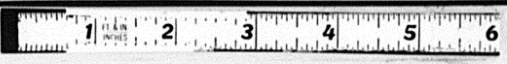

**THIS PAGE INTENTIONALLY LEFT BLANK**